

Gas-Actuated Thermometers, Rigid Stem

Bayonet ring case stainless steel
with limit switch contact assembly

TSCh
TSChOe

This data sheet contains information on the number of the maximum possible contacts, the electrical connections, the ordering information and the options of the models TSCh and TSChOe with limit switch contact assembly with standard/magnetic, electronic or inductive contacts, furthermore dimensional drawings with the position of the electrical connections.

Data sheet 8201 contains all details of the available versions of the models TSCh resp. TSChG without limit switch contact assembly. These information as well as as the required ordering information are also valid for the version with limit switch contact assembly, as far as not described differently.

For liquid-filled thermometers with limit switch contact assembly a special oil is used instead of silicone oil. The model code for instruments with case filling is TSChOe.

In **model overview 9.1000** definitions, applications and functions of the particular models of the limit switch contact assemblies are described generally and in detail. It also contains comprehensive information on the selection, switching functions and minimum spans, operating conditions, Ex-protection, options and others.



Standard Versions

Available limit switch contact assemblies

1. **Direct** (electromechanical)
 - 1.1 Standard contact **S**
 - 1.2 Magnetic contact **M**
2. **Indirect** (contactless)
 - 2.1 Electronic contact **E**
 - 2.2 Inductive contact **I**
 - 2.3 Pneumatic contact **P** upon request

Number of the maximum possible contacts

	NCS 100 case filling		NCS 160 case filling	
	without	with	without	with
up to 3 x S	○	—	○	—
4 x S ¹⁾	upon request	—	○	—
up to 3 x M	○	○	○	○
4 x M ¹⁾	upon request	—	○	upon request
up to 3 x E	○	○	○	○
4 x E	upon request	—	upon request	upon request
up to 3 x I	○	○	○	○
4 x I	upon request	—	upon request	upon request

○ = available

¹⁾ alternatively as double change-over contact

Case Protection Type (EN 60 529 / IEC 529)

IP 65

Nominal Case Size

100, 160 (mm) (4", 6")

Window

Polycarbonate

Adjusting Mechanism Limit Setting Pointer

All instruments have an adjustable lock in the window. The limit setting pointer is set to the value at which the switching operation should happen, externally by the removable key.

Electrical Connection

- for limit switch contact assembly (S/M): plug connector
- for limit switch contact assembly (E) : cable connection box black
- for limit switch contact assembly (I) : cable connection box blue,
for identification of an intrinsically safe circuitry, otherwise as E

Plug Connector and Cable Connection Box

IP 65, 6-pin, with M 20 x 1.5 screwed cable gland with pull relief, terminals numbered according to wiring diagram (at the instrument), protective contact available

Plug Connector

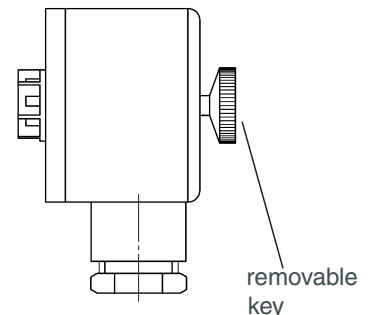
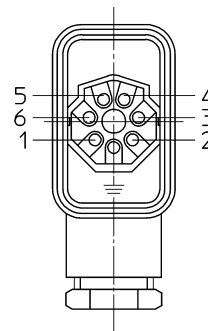

Cable Connection Box

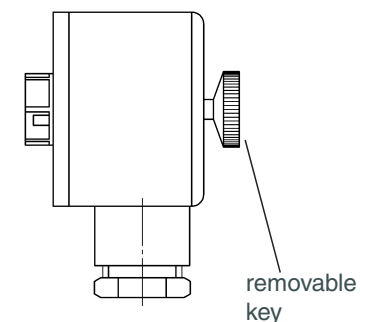
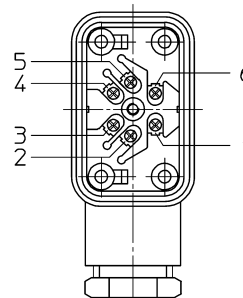

The position of the electrical connection can be seen on the dimensional drawings, see page 2 and page 4 (cable entry).



Sales and Export South, West, North

ARMATURENBau GmbH

Manometerstraße 5 • D-46487 Wesel - Ginderich
Tel.: +49 (0)28 03/91 30-0 • Fax: +49 (0)28 03/10 35
armaturenbaum.com • mail@armaturenbaum.com

Subsidiary Company, Sales and Export East

MANOTHERM Beierfeld GmbH 8201.90

Am Gewerbepark 9 • D-08344 Grünhain-Beierfeld
Tel.: +49 (0)37 74/58-0 • Fax: +49 (0)37 74/58-545
manotherm.com • mail@manotherm.com

Case Configurations, Code Letters, Dimensional Data and Weights

Compared to the basic models there are deviations in the front-to-back sizes, see table.
The remaining dimensions can be seen on data sheet 8201.

Bottom Stem Position

without code letters

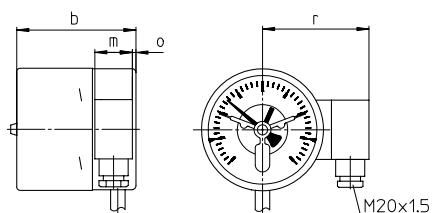

Centre Back Stem Position

code letters: **rm**

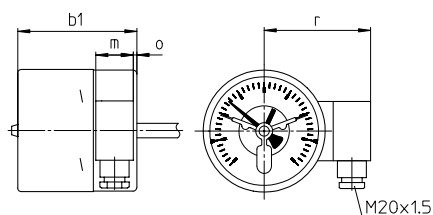

with back flange for surface mounting (back flange)

code letters: **rmRh**

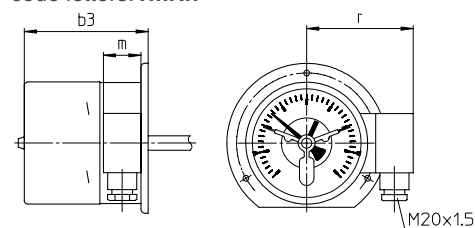

Dimensional Data (mm / inches) and Weights (kg / lb)

NCS/Model	b / b1	b3	m	o	r	approx. weight ¹⁾	
						TSCh	TSChOe
100 1, 2 and 3 contacts	99 3.9	103 4.06	31 1.22	3 0.12	94 3.7	0.80 1.76	1.35 2.98
100 4 contacts	106 4.17	110 4.33	31 1.22	3 0.12	94 3.7	0.80 1.76	-
160 all limit switch contact assemblies with 1 and 2 contacts (I11, I22, see next line)	105 4.13	108 4.25	31 1.22	6 0.24	121 4.76	1.30 2.86	2.90 6.39
160 all limit switch contact assemblies with 3 and 4 contacts and I11 and I22	115 4.53	118 4.65	31 1.22	6 0.24	121 4.76	1.35 2.98	3.00 6.61

¹⁾ The information is an example and relates to model TSCh resp. TSChOe, A3, dF 12, L = 200 mm, G½, E12 resp. M1221

Ordering Information, Limit Setting Pointer

Basic Model: Gas-actuated thermometers with rigid stem with limit switch contact assembly **TSCh, TSChOe**

Ordering information

	When installing limit switch contact assemblies, the ordering code of the basic model is extended by		
code letters	S	standard contact	
	M	magnetic contact	e.g. M
	E	electronic contact	
	I	inductive contact	
code number	1	making contact	
for the switching function	2	breaking contact	e.g. 2
(clockwise direction of action, that means for pressure gauges at rising pressure)	3	single change-over contact as standard or magnetic contact	
	11	1. and 2. making contact	
	12	1. making contact / 2. breaking contact	
	21	1. breaking contact / 2. making contact	
	22	1. and 2. breaking contact	
	33	double change-over contact as standard or magnetic contact	
Details	For an optimal function of the instruments with limit switch contact assemblies you have to add the following to the ordering information: - switching temperature(s) - switching range(s) that are beyond the adjustment ranges that are defined by us - if an anticlockwise switching direction is requested Information on limit switch contact assemblies with 3 or 4 contacts see below		
Options	for all limit switch contact assembly models	adjustable lock with non-removable key limit switch contact assembly with pneumatic contact or with micro switch upon request switching distance fixing (2 contacts and above) upon request	<i>(order at the moment still as clear text)</i>
	S/M contacts	separated circuitries wire break control (parallelly switched resistor for each contact) contact pins made of special materials upon request	
	E-contacts	PNP switching output as 2-wire connection	
	I-contacts	safety version SN or S1N interval switching reactionless for NCS 160 with 2 contacts, interval relay required	
	options of electrical connection see page 4 other position of the electrical connection upon request		

Example: TSChOe 100 rm, 0 - 200 °C, A3, dF 12, L = 150 mm, G½, E1

Information on limit switch contact assemblies with 3 and 4 contacts

Compared to thermometers with 2 contacts the limit setting pointers of thermometers with 3 or 4 contacts are not adjustable one above the other in every case.

Behaviour of the limit setting pointers to each other

Model Limit switch contact assembly	3 limit setting pointers		4 limit setting pointers	
	NCS 100	NCS 160	NCS 100	NCS 160
S, M	adjustment one above the other		only 3 adjustable one above the other in each case	
E, I	only 3 adjustable one above the other in each case		only the two pointers in the middle adjustable one above the other	only 3 adjustable one above the other in each case

Switching function

The limit setting pointers, that are not adjustable one above the other for limit switch contact assemblies with 3 and 4 contacts are separated by a point when indicating the switching function.

Example: M 222.1 4-fold; 3rd and 4th limit setting pointer not adjustable one above the other
E 1.22.1 4-fold; only the two pointers in the middle are adjustable one above the other

Minimum distance of the not adjustable (one above the other) pointers in angular degrees

Model Limit switch contact assembly	NCS 100	NCS 160
S, M	15	10
E, I	35	28

Options

Electrical Connection

Cable entry

- for instruments without case filling
- IP 65
- cable entry M 12 x 1.5 with pull relief and 1 m connection cable
- available for max. 4 x S / M

more than 1 m connection cable upon request

Bottom Stem Position

Centre Back Stem Position

with back flange for surface mounting

without code letters

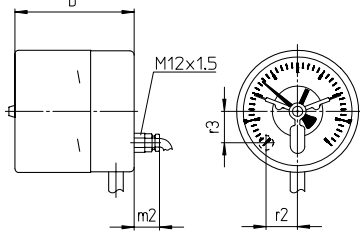

code letters: **rm**

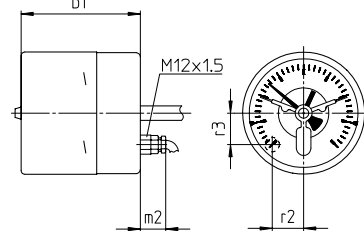

code letters: **rmRh**

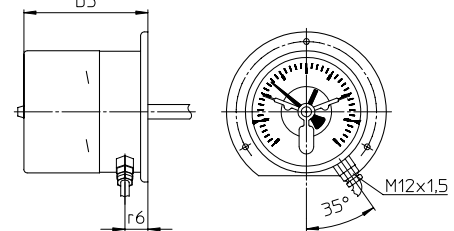

Dimensional Data (mm / inches) and Weights (kg / lb)

NCS/model	b / b1	b3	m2	r2	r3	r6	approx. weight ¹⁾ TSCb
100 1, 2 and 3 contacts	99 / 3.9	103 / 4.06	21 / 0.83	26 / 1.02	26 / 1.02	21 / 0.83	0.80 / 1.76
100 4 contacts	106 / 4.17	110 / 4.33	21 / 0.83	26 / 1.02	26 / 1.02	21 / 0.83	0.80 / 1.76
160 all limit switch cont. assemb. with 1 and 2 contacts	105 / 4.13	108 / 4.25	21 / 0.83	36 / 1.42	50 / 1.97	18 / 0.71	1.30 / 2.86
160 all limit switch cont. assemb. with 3 and 4 contacts	115 / 4.53	118 / 4.65	21 / 0.83	36 / 1.42	50 / 1.97	18 / 0.71	1.35 / 2.97

Plug connector DIN EN 17 5301-803

- IP 65, 3-pin and protective contact
- available for max. 2x S / M or 1x E / I
- resp. 2x E / I at option PNP-switching output as 2-wire connection

Plug connector DIN EN 17 53 01-803 construction type A - for instruments without case filling

Bottom Stem Position

without code letters

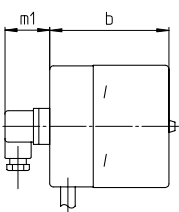

Centre Back Stem Position

code letters: **rm**

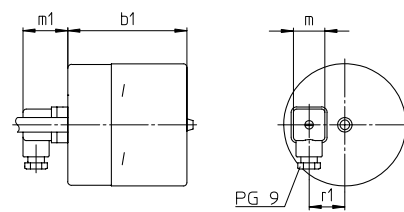

Dim. Data (mm / inches) and Weights (kg / lb)

NCS	b / b1	m	m1	r1	approx. weight ¹⁾ TSCb
100	99	26	37	29.50	0.80
4"	3.9	1.02	1.46	1.16	1.76
160	105	26	37	55	1.30
6"	4.13	1.02	1.46	2.17	2.86

Plug connector DIN EN 17 53 01-803 construction type C - for instruments without and with case filling

Bottom Stem Position

without code letters

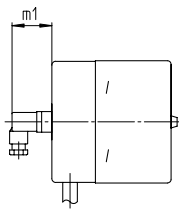

Centre Back Stem Position

code letters: **rm**

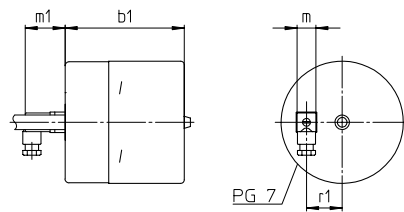

Dim. Data (mm / inches) and Weights (kg / lb)

NCS	b / b1	m	m1	r1	approx. weight ¹⁾ TSCb	approx. weight ¹⁾ TSCbG
100	99	26	37	29.50	0.80	1.35
4"	3.9	1.02	1.46	1.16	1.76	2.97
160	105	26	37	55	1.30	2.90
6"	4.13	1.02	1.46	2.17	2.86	6.39

Circular plug connector M 12 x 1.5

- for instruments with and without case filling
- IP 67, 4-pin without protective contact
- available for max. 2 x E / I
- with 2 m die casted cable upon request

angular cable box

straight cable box upon request



The circular plug connectors have approximately the same position of connection as the cable entries, see above.

¹⁾ The information is an example and relates to model TSCb resp. TSCbOe, A3, dF 12, L = 200 mm, G½, M12 resp. M1122