

# Gas-Actuated Thermometers, Rigid Stem

Bayonet ring case stainless steel

**TSCh**  
**TSChG**

## Standard Versions

Information on selection and metrological features (temperature-resistance, among others) and temperature ranges / smallest subdivision / error limits can be found in model overview 8000.

### Measuring Unit

with nitrogen filling  
(inert gas, physiologically safe)

### Accuracy (EN 13 190)

Class 1

### Case

With bayonet ring, stainless steel 1.4301

### Case Protection Type (EN 60 529 / IEC 529)

IP 65

### Case Filling

For model TSChG: silicone oil

### Nominal Case Sizes

TSCh: 63, 100, 160, 250 mm (2½", 4", 6", 10")

TSChG: 63, 100, 160 mm (2½", 4", 6")

### Case Configuration

Connection temperature

sensor (stem): rigid connection with neck tube

Stem position:

vertical bottom position,  
optional: with angle (**w**, **wst**, **wl**, **wr**) or  
centre back position (**rm**),  
see page 2

Mounting device:

without,  
optional: for centre back connection (**rm**),  
back flange for surface mounting (**Rh**),  
see page 2

### Temperature Ranges (EN 13 190)

Temperature differences from 80 K to 600 K

### Temperature Sensor (Stem)

made of stainless steel 1.4571 (316 L),

max. static operating pressure: 25 bar

Stem models: A1, A3, A4, A4.1, A5 or A6,

Stem-Ø dF: 8, 10 or 12 mm

Stem length L resp. L1: Lmin resp. L1min up to max. 2.50 m

Please consider the minimum stem length depending on the active length (La) and stem model, see page 3.

### Window

Instrument glass

### Movement

Brass/German silver

### Dial

Aluminium white, scaling black

### Pointer

Aluminium, black

### Indication Adjustment (±6%)

From the outside via screw



## Ordering Information, Standard Temperature Ranges, Options

See page 4

## Special Versions and further Options among others

- Other stem models, e. g.
  - without bent tube, see data sheet 8299.1
  - with connection for food / biotechnical / pharmaceutical industry, see data sheet 8299.3
  - contact stems for temperature measurement on the outside of cases and pipe barrels up to 300 °C, see data sheet 8299.4
- Other stem-Ø, connection threads and materials upon request
- Other temperature ranges and/or special scales, e.g. dual scale °C/°F, coloured fields or ranges, dial inscriptions, etc.
- Stationary red pointer, min. or max. drag indicator upon request
- Case parts stainless steel 316 L (1.4404) upon request
- Model TSCh for ambient temperatures to -60 °C upon request; Model TSChG for ambient temperatures to -40 °C. For ambient temperatures below -20 °C we recommend: thermometers with crimped-on ring case model TSChg resp. TSChgG
- Position of connection at 3 o'clock, 9 o'clock, 12 o'clock, others upon request or other than vertical installation (90°)
- GOST-version for Russia, Ukraine, Kazakhstan

## Accessories

Mechanical: thermowells, see DS 8.8110 ff.

Electrical: limit switch contact assemblies,  
see catalogue-heading 9.1



Sales and Export South, West, North

**ARMATURENBAU GmbH**

Manometerstraße 5 • D-46487 Wesel-Ginderich  
Tel.: +49 (0) 28 03 / 91 30-0 • Fax: +49 (0) 28 03 / 10 35  
armaturenbau.com • mail@armaturenbau.com

Subsidiary Company, Sales and Export East

**MANOTHERM Beierfeld GmbH**

Am Gewerbepark 9 • D-08344 Grünhain-Beierfeld  
Tel.: +49 (0) 37 74 / 58-0 • Fax: +49 (0) 37 74 / 58-545  
manotherm.com • mail@manotherm.com

**8201**

04/14

# Stem Position / Case Configurations, Code Letters, Dimensional Data and Weights

## Vertical Bottom Stem Position

no additional code letters

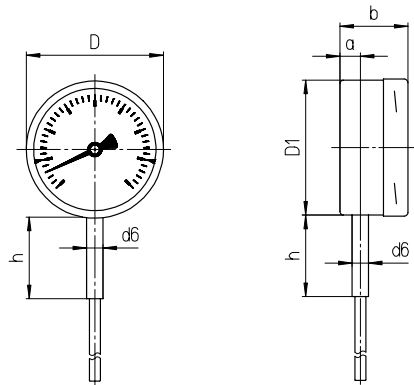

A1  
also A5

## Further Stem Models

(demonstrated as example: vertical bottom stem position)

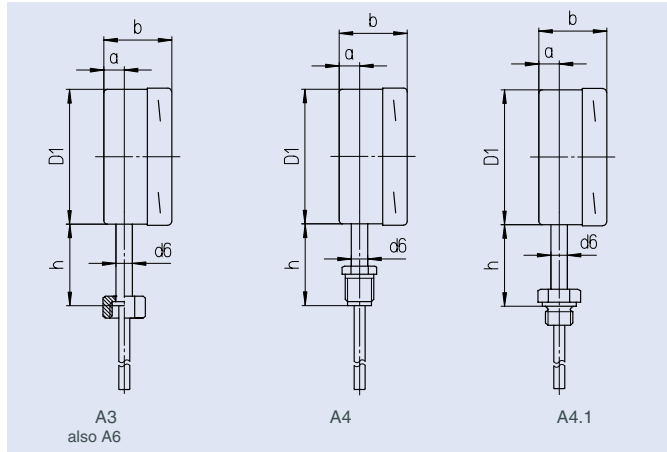

A3  
also A6

A4

A4.1

## Vertical Bottom Stem Position with angle

with angle:

90° angled to the back,  
code letter **w**

obtuse-angled to the back,  
code letter **wst**

right-angled to the left,  
code letters **wl**

right-angled to the right,  
code letters **wr**

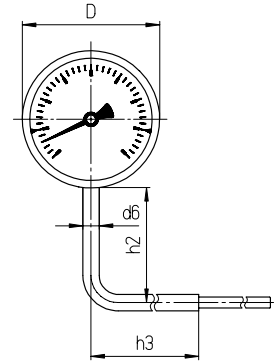
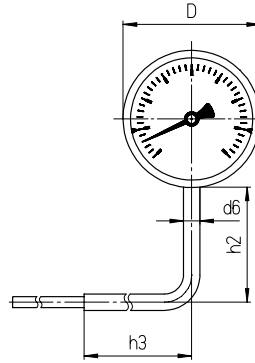
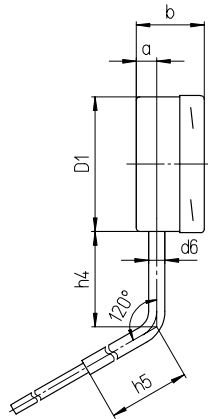
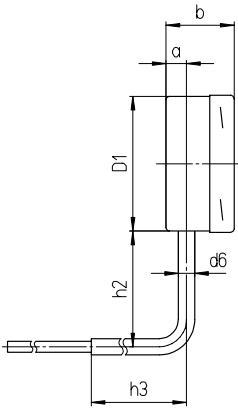

## Centre Back Stem Position

code letters **rm**

with back flange for surface mounting (back flange),  
code letters **rmRh**

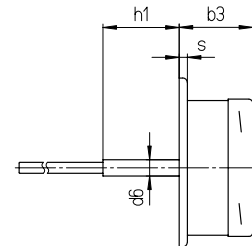
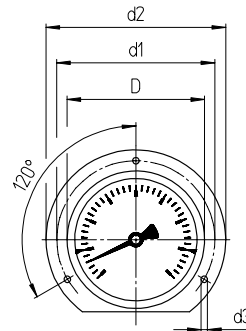
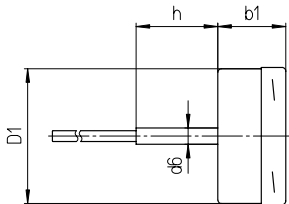
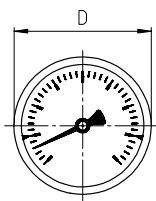

## Dimensional Data (mm / inches) and Weights (kg / lb)

NCS	a	b	b1	b3	D	D1	d1	d2	d3	d6	h <sup>1)</sup>	h1 <sup>1)</sup>	h2	h3	h4	h5	s	approx. weight <sup>2)</sup>	
																		TSch	TSchG
63	12	39	39	42	64	62	75	85	3.6	12	60	57	85	120	70	120	5	0.24	0.32
2½"	.47	1.54	1.54	1.65	2.52	2.44	2.95	3.35	.14	.47	2.36	2.24	3.35	4.72	2.76	4.72	.2	0.53	0.70
100	15	50	50	53.5	101	99	116	132	4.8	12	60	56.5	85	120	70	120	6	0.46	0.72
3"	.59	1.97	1.97	2.10	3.98	3.9	4.57	5.2	.19	.47	2.36	2.22	3.35	4.72	2.76	4.72	.24	1.01	1.59
160	15	50	50	53	161	159	178	196	5.8	12	60	57	85 <sup>3)</sup>	120	70 <sup>3)</sup>	120	6	0.78	1.50
6"	.59	1.97	1.97	2.09	6.34	6.26	7.01	7.72	.23	.47	2.36	2.24	3.35	4.72	2.76	4.72	.24	1.72	3.30
250	15	57	57	—	251	249	270	285	5.8	12	60	—	109	120	70	120	—	1.83	—
10"	.59	2.24	2.24	—	9.88	9.8	10.62	11.22	.23	.47	2.36	—	4.29	4.72	2.76	4.72	—	4.03	—

<sup>1)</sup> Temperature range > 500 °C and higher: +20 mm (0.79")

<sup>2)</sup> The indications serve as example and relate to versions with stem A1, Ø 10 mm (0.4"), length 200 mm (8").

<sup>3)</sup> For TSChG: h2 = 109 mm (4.29"), h4 = 94 mm (3.7")

# Stem Models

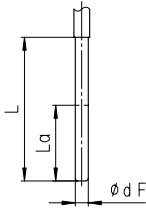
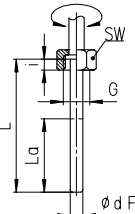
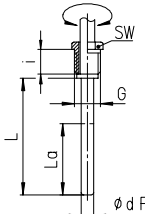
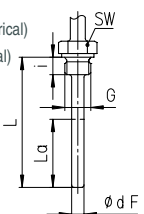
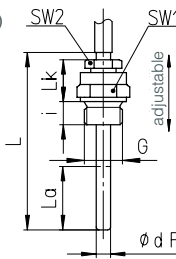
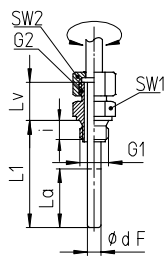
Stem Models																																																																																									
<b>Process connection:</b>		<b>without screw fitting, plain stem</b>																																																																																							
<b>Stem model:</b>	<b>A1</b>																																																																																								
<b>Form according to DIN 13 190:</b>	Form 1																																																																																								
<b>Stem material:</b>	1.4571																																																																																								
<b>Stem-Ø dF:</b>	8, 10, 12																																																																																								
<b>Order length:</b>	L																																																																																								
<b>Data sheet</b> (suitable thermowell models):	8.8140 (SK1), 8.8141 (SK2)																																																																																								
																																																																																									
<b>Process connection:</b>		<b>Union nut</b>		<b>Male thread, turnable</b>		<b>Male thread, rigid</b>																																																																																			
<b>Stem model:</b>	<b>A3</b>		<b>A4</b>		<b>A4.1</b>																																																																																				
<b>Form according to DIN 13 190:</b>	Form 5		Form 4		Form 6 (thread cylindrical) Form 7 (thread conical)																																																																																				
<b>Stem material:</b>	1.4571		1.4571		1.4571																																																																																				
<b>Stem-Ø dF:</b>	8, 10, 12		8, 10, 12		8, 10, 12																																																																																				
<b>Screw fitting material:</b>	1.4571		1.4571		1.4571																																																																																				
<b>Order length:</b>	L		L		L																																																																																				
<b>Data sheet</b> (suitable thermowell models):	8.8111 (SF4.1), 8.8113 (SF4.1F) 8.8130 (SF8), 8.8131 (SF9)		8.8110 (SF4), 8.8112 (SF4F) 8.8120 (SF5), 8.8121 (SF6+SF7)		8.8110 (SF4), 8.8112 (SF4F) 8.8120 (SF5), 8.8121 (SF6+SF7)																																																																																				
																																																																																									
<b>Thread (dimensions in mm):</b>	<table border="1"> <thead> <tr><th>G</th><th>SW</th><th>i</th></tr> </thead> <tbody> <tr><td>G 1/2</td><td>27</td><td>10</td></tr> <tr><td>G 3/4</td><td>32</td><td>12</td></tr> <tr><td>M 20x1.5</td><td>27</td><td>10</td></tr> <tr><td>M 24x1.5</td><td>32</td><td>12</td></tr> <tr><td>M 27x2</td><td>32</td><td>12</td></tr> </tbody> </table>		G	SW	i	G 1/2	27	10	G 3/4	32	12	M 20x1.5	27	10	M 24x1.5	32	12	M 27x2	32	12	<table border="1"> <thead> <tr><th>G</th><th>SW</th><th>i</th></tr> </thead> <tbody> <tr><td>G 1/2 B</td><td>22</td><td>20</td></tr> <tr><td>G 3/4 B</td><td>27</td><td>23</td></tr> <tr><td>M 18x1.5</td><td>22</td><td>14</td></tr> <tr><td>M 20x1.5</td><td>22</td><td>20</td></tr> </tbody> </table>		G	SW	i	G 1/2 B	22	20	G 3/4 B	27	23	M 18x1.5	22	14	M 20x1.5	22	20	<table border="1"> <thead> <tr><th>G</th><th>SW</th><th>i</th></tr> </thead> <tbody> <tr><td>G 1/2 B</td><td>27</td><td>14</td></tr> <tr><td>G 3/4 B</td><td>32</td><td>16</td></tr> <tr><td>1/2" NPT</td><td>27</td><td>19</td></tr> <tr><td>3/4" NPT</td><td>27</td><td>19</td></tr> <tr><td>M 18x1.5</td><td>24</td><td>14</td></tr> <tr><td>M 20x1.5</td><td>27</td><td>14</td></tr> </tbody> </table>			G	SW	i	G 1/2 B	27	14	G 3/4 B	32	16	1/2" NPT	27	19	3/4" NPT	27	19	M 18x1.5	24	14	M 20x1.5	27	14																												
G	SW	i																																																																																							
G 1/2	27	10																																																																																							
G 3/4	32	12																																																																																							
M 20x1.5	27	10																																																																																							
M 24x1.5	32	12																																																																																							
M 27x2	32	12																																																																																							
G	SW	i																																																																																							
G 1/2 B	22	20																																																																																							
G 3/4 B	27	23																																																																																							
M 18x1.5	22	14																																																																																							
M 20x1.5	22	20																																																																																							
G	SW	i																																																																																							
G 1/2 B	27	14																																																																																							
G 3/4 B	32	16																																																																																							
1/2" NPT	27	19																																																																																							
3/4" NPT	27	19																																																																																							
M 18x1.5	24	14																																																																																							
M 20x1.5	27	14																																																																																							
				Thermowell required!																																																																																					
<b>Process connection:</b>		<b>Male thread / compression</b>			<b>Male thread, turnable / double male adapter</b>																																																																																				
<b>Stem model:</b>	<b>A5</b>			<b>A6</b>																																																																																					
	(= basic stem A1 with compression fitting)			(= basic stem A3 with double male adapter)																																																																																					
<b>Form according to DIN 13 190:</b>	Form 2 (thread cylindrical) Form 3 (thread conical)			—																																																																																					
<b>Stem material:</b>	1.4571			1.4571																																																																																					
<b>Stem-Ø dF:</b>	8, 10, 12			8, 10, 12																																																																																					
<b>Screw fitting material:</b>	1.4571			1.4571																																																																																					
<b>Order length:</b>	L			L1																																																																																					
<b>Data sheet</b> (suitable thermowell models):	8.8110 (SF4), 8.8112 (SF4F) 8.8120 (SF5), 8.8121 (SF6+SF7)			8.8110 (SF4), 8.8112 (SF4F) 8.8120 (SF5), 8.8121 (SF6+SF7)																																																																																					
																																																																																									
<b>Thread (dimensions in mm):</b>	<table border="1"> <thead> <tr><th>G</th><th>SW1</th><th>SW2</th><th>i</th><th>Lk</th></tr> </thead> <tbody> <tr><td>G 1/2 B</td><td>27</td><td>22</td><td>14</td><td>42</td></tr> <tr><td>G 3/4 B</td><td>32</td><td>22</td><td>16</td><td>42</td></tr> <tr><td>1/2" NPT</td><td>27</td><td>22</td><td>19</td><td>42</td></tr> <tr><td>3/4" NPT</td><td>27</td><td>22</td><td>19</td><td>42</td></tr> <tr><td>M 20x1.5</td><td>27</td><td>22</td><td>14</td><td>42</td></tr> </tbody> </table>					G	SW1	SW2	i	Lk	G 1/2 B	27	22	14	42	G 3/4 B	32	22	16	42	1/2" NPT	27	22	19	42	3/4" NPT	27	22	19	42	M 20x1.5	27	22	14	42	<table border="1"> <thead> <tr><th>G1</th><th>G2</th><th>SW1</th><th>SW2</th><th>i</th><th>Lv</th></tr> </thead> <tbody> <tr><td>G 1/2 B</td><td>G 1/2 B</td><td>27</td><td>27</td><td>14</td><td>28</td></tr> <tr><td>G 3/4 B</td><td>G 1/2 B</td><td>32</td><td>27</td><td>16</td><td>28</td></tr> <tr><td>1/2" NPT</td><td>G 1/2 B</td><td>27</td><td>27</td><td>19</td><td>28</td></tr> <tr><td>3/4" NPT</td><td>G 1/2 B</td><td>27</td><td>27</td><td>19</td><td>28</td></tr> <tr><td>M 20x1.5</td><td>M 20x1.5</td><td>27</td><td>27</td><td>14</td><td>28</td></tr> <tr><td>M 24x1.5</td><td>M 20x1.5</td><td>32</td><td>27</td><td>14</td><td>28</td></tr> <tr><td>M 27x2</td><td>M 20x1.5</td><td>32</td><td>27</td><td>16</td><td>28</td></tr> </tbody> </table>						G1	G2	SW1	SW2	i	Lv	G 1/2 B	G 1/2 B	27	27	14	28	G 3/4 B	G 1/2 B	32	27	16	28	1/2" NPT	G 1/2 B	27	27	19	28	3/4" NPT	G 1/2 B	27	27	19	28	M 20x1.5	M 20x1.5	27	27	14	28	M 24x1.5	M 20x1.5	32	27	14	28	M 27x2	M 20x1.5	32	27	16	28
G	SW1	SW2	i	Lk																																																																																					
G 1/2 B	27	22	14	42																																																																																					
G 3/4 B	32	22	16	42																																																																																					
1/2" NPT	27	22	19	42																																																																																					
3/4" NPT	27	22	19	42																																																																																					
M 20x1.5	27	22	14	42																																																																																					
G1	G2	SW1	SW2	i	Lv																																																																																				
G 1/2 B	G 1/2 B	27	27	14	28																																																																																				
G 3/4 B	G 1/2 B	32	27	16	28																																																																																				
1/2" NPT	G 1/2 B	27	27	19	28																																																																																				
3/4" NPT	G 1/2 B	27	27	19	28																																																																																				
M 20x1.5	M 20x1.5	27	27	14	28																																																																																				
M 24x1.5	M 20x1.5	32	27	14	28																																																																																				
M 27x2	M 20x1.5	32	27	16	28																																																																																				
<b>Minimum Stem Length, Active Length and maximum realisable Stem Length</b>																																																																																									
			up to max. 500 °C			500 °C and above			<p>The <b>minimum length Lmin / L1min</b> of the stem is the smallest possible stem length depending on the active length La (temperature-sensitive part) and the stem model.</p> <p>The <b>active length La</b> of the stem (temperature-sensitive part) has to immerse completely into the medium, in order to obtain a measuring result that corresponds to the accuracy class.</p> <p>The <b>maximum realisable stem length</b> is 2.50 m. Greater lengths can be obtained with a capillary line, e.g. with special stems A3.2, A4.2 and A4.3 (data sheet 8299.1) or basic models TFCh with capillary line to stem, data sheet 8221.</p>																																																																																
<b>Stem model:</b>	<b>Length:</b>	<b>Thread:</b>	<b>Stem-Ø dF:</b>			<b>Stem-Ø dF:</b>																																																																																			
<b>all models</b>	La	all standard threads	12	10	8	12	10	8																																																																																	
<b>A1 A3 A4</b>	Lmin	all standard threads	35	45	75	75	105	165																																																																																	
<b>A4.1</b>	Lmin	all standard threads	55	65	95	95	125	185																																																																																	
		G 1/2 B, M 18x1.5, M 20x1.5	49	59	89	89	119	179																																																																																	
		G 3/4 B	51	61	91	91	121	181																																																																																	
<b>A5</b>	Lmin	1/2" NPT, 3/4" NPT	54	64	94	94	124	184																																																																																	
		all standard threads	90	100	130	130	160	220																																																																																	
<b>A6</b>	L1min	G 1/2 B, M 20x1.5	49	59	89	89	119	179																																																																																	
		G 3/4 B, M24x1.5, M27x2	51	61	91	91	121	181																																																																																	
		1/2" NPT, 3/4" NPT	54	64	94	94	124	184																																																																																	
<b>others</b>			upon request			upon request																																																																																			

## Ordering Information with Indication and Temperature Ranges, Options

Basic Model:	Gas-actuated Thermometers, Rigid Connection to Stem		TSch	
<b>Case filling:</b>	without		no code letters	
	silicone oil		<b>G</b>	
<b>Nominal case size:</b>	Case-Ø 63, 100, 160, 250 mm (2½", 4", 6", 10") (NCS 250 not with case filling)		<b>63, 100, 160, 250</b>	
<b>Stem position / Case configuration:</b>	vertical bottom position		no code letters	
	90° angled to the back		<b>w</b>	
	obtuse-angled to the back		<b>wst</b>	
	right-angled to the left		<b>wl</b>	
	right-angled to the right		<b>wr</b>	
	centre back position		<b>rm</b>	
	centre back position, with back flange for surface mounting		<b>rmRh</b>	
<b>Temperature ranges:</b>	scale:	Δ T (K):		
	0 – 80 °C	80		
	0 – 100 °C	100	e.g. <b>0 – 100 °C</b>	
	0 – 120 °C	120		
	0 – 160 °C	160		
	0 – 200 °C	200		
	0 – 250 °C	250		
	0 – 300 °C	300		
	0 – 400 °C	400		
	0 – 500 °C	500		
	0 – 600 °C	600		
	-100 / + 100 °C	200		
	-50 / + 50 °C	100		
	-40 / + 40 °C	80		
	-40 / + 60 °C	100		
	-30 / + 50 °C	80	e.g. <b>-30/+50 °C</b>	
	-20 / + 60 °C	80		
	-20 / + 80 °C	100		
+50 / +300 °C	250			
+50 / +400 °C	350			
+100 / +500 °C	400			
<b>Stem:</b>	without screw fitting, plain stem		<b>A1</b>	
	union nut		<b>A3</b>	
	male thread, turnable		<b>A4</b>	
	male thread, rigid		<b>A4.1</b>	
	male thread / compression fitting		<b>A5</b>	
	male thread, turnable / double-male adapter		<b>A6</b>	
<b>Stem-Ø dF:</b>	8, 10 or 12 mm		<b>dF 8, 10, 12</b>	
<b>Stem length:</b>	L resp. L1 in mm	e.g.	<b>L = 100 mm</b>	
<b>Process connection:</b>	see page 3	e.g.	<b>G ½ B</b>	
<b>Options:</b>	red mark	on the dial		
	plastic clip	red or green external on crimped-on ring for NCS 100 and 160		
	stationary red pointer	on the dial		
		adjustable with removable ring		
	window	laminated safety glass		
		acrylic glass (PMMA)		
		polycarbonate (PC) (not NCS 250)		
	movement	stainless steel		
	case ventilation no. 22 for outdoor installation			<i>(order at present still in cleartext)</i>
	case polished			
	bayonet ring polished			
	Version:	dial marking with corresponding symbol		
German Lloyd or Russian Sea Register				
<b>TSch 100, 160</b>	copy of the certificate upon request			
<b>TSchG 63, 100, 160</b>				
measuring point marking	stainless steel plate 12 mm x 55 mm (0.47" x 2.17") with wire mounting or sticker on case coverage			

**Example:** TSch 100 w, 0 – 100 °C, A3, dF 8, L = 100 mm, G ½

**Special Versions:** Please describe your requirements in cleartext