

VacuSeal™ Fittings

May 2011

aerospace
climate control
electromechanical
filtration
fluid & gas handling
hydraulics
pneumatics
process control
sealing & shielding

Contents

Introduction

Page 1

Glands

Pages 2, 3, 4



Bodies

Pages 4, 5, 6, 7

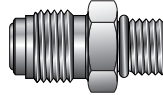

Welded Assemblies

Page 8

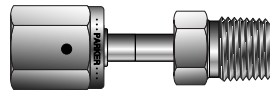

Welded Modules

Page 9

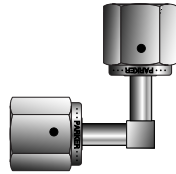

Gaskets

Page 10



Nuts, Caps, and Plugs

Page 11



Hi-Flo Products

Page 12



Featured Products

Page 13

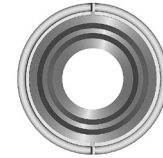

Make-Up Instructions

Page 14

Ordering Instructions

Page 15

Parker Veriflo Division



⚠ WARNING – USER RESPONSIBILITY

FAILURE OR IMPROPER SELECTION OR IMPROPER USE OF THE PRODUCTS DESCRIBED HEREIN OR RELATED ITEMS CAN CAUSE DEATH, PERSONAL INJURY AND PROPERTY DAMAGE.

This document and other information from Parker-Hannifin Corporation, its subsidiaries and authorized distributors provide product or system options for further investigation by users having technical expertise.

The user, through its own analysis and testing, is solely responsible for making the final selection of the system and components and assuring that all performance, endurance, maintenance, safety and warning requirements of the application are met. The user must analyze all aspects of the application, follow applicable industry standards, and follow the information concerning the product in the current product catalog and in any other materials provided from Parker or its subsidiaries or authorized distributors.

To the extent that Parker or its subsidiaries or authorized distributors provide component or system options based upon data or specifications provided by the user, the user is responsible for determining that such data and specifications are suitable and sufficient for all applications and reasonably foreseeable uses of the components or systems.

Proposition 65 Warning: This product contains chemicals known to the state of California to cause cancer or birth defects or other reproductive harm.

Offer of Sale

The items described in this document are hereby offered for sale by Parker-Hannifin Corporation, its subsidiaries or its authorized distributors. This offer and its acceptance are governed by the provisions stated in the detailed "Offer of Sale" elsewhere in this document or available at www.parker.com/veriflo.

© Copyright 2009 Parker Hannifin Corporation. All Rights Reserved.

Introduction

Parker UHP fittings are designed as leak-free components for critical applications where ultra-high pure conditions are required. VacuSeal™ products, with their mating gasket and toroid design, provide a metal-to-metal seal with leak-free service from vacuum to positive pressure.

Featured Products (see page 13)

- **TorqTite™** gasket to seal damaged toroids and virtually eliminate loosening of componentry due to thermocycling and vibration.
- **High-Purity Nickel and Hastelloy C-22®** glands for extremely corrosive applications.
- **Non-Rotational Female Nut** to prevent transmission of torque during make-up and therefore minimize twist of componentry which causes stress concentration.
- **Anti-Galling Female Nut** to ensure consistent make-up without plating or lubrication.

Materials

Typical Raw Material Specifications

FITTING MATERIAL	BAR STOCK	FORGINGS	RECOMMENDED TUBING SPECIFICATIONS
Stainless Steel 316	ASTM A276, ASME SA479	ASME SA182	ASME SA213, ASTM A213, ASTM A249
Stainless Steel 316L	ASTM A276, ASME SA479	ASME SA182	ASME SA213, ASTM A213, ASTM A249
Stainless Steel 316L VAR (Vacuum Arc Remelt)	ASTM A276, ASME SA479	ASME SA182	ASTM A269, MIL T8504, MIL T8506
Stainless Steel 316L VIM/VAR (Vacuum Induction Melt/Vacuum Arc Remelt)	ASTM A276, ASME SA479	ASME SA182	ASTM A269, MIL T8504, MIL T8506

Material is marked with heat code to ensure raw material traceability.

Gaskets Typical Raw Material Specifications

MATERIAL SPECIFICATIONS	
Nickel	ASTM B162 (unplated)
Stainless Steel	ASTM A167 (Silver plated)

Hastelloy C-22® is a registered trademark of Haynes International, Inc.

Specifications

- **Pressure Ratings** are based upon tests conducted on VacuSeal™ assemblies. All ratings comply with calculations per ANSI Code for Pressure Piping B31.3. **Working Pressures** are rated at ambient temperature and are based on a 4 to 1 design factor. To determine pressure ratings in accordance with ANSI B31.1, multiply **Working Pressure** by 0.94.
- **Temperature Ratings**
Fittings:
Stainless Steel 316, 316L, 316L VAR, 316L VIM/VAR 1000°F (537°C)
Gaskets:
High-Purity Nickel 600°F (315°C)
Silver plated Stainless Steel 1000°F (537°C)
- **Dimensions** are for reference only and are subject to change. Tube ends conform to the dimensional requirements of ASTM A269.
- **Plating:** VacuSeal™ Female Nuts are Silver plated with an enhanced plating process. Avoid aggressive chemical processes used for cleaning, electropolishing and passivation that will remove plating. Removal or damage to plating will cause threads to gall, damaging fitting components and preventing a proper seal.
- **Testing:** VacuSeal™ products are rated to a Helium leak rate of 1×10^{-9} STD cc/sec.
- **Internal Surface Finishes:** VacuSeal™ components are available with controlled surface finishes to meet requirements of Ultra-High Purity systems.
- **Cleaning and Packaging:** Ultra-High Purity cleaning and packaging in a Class 100 Clean Room environment, is standard for all VacuSeal™ components.

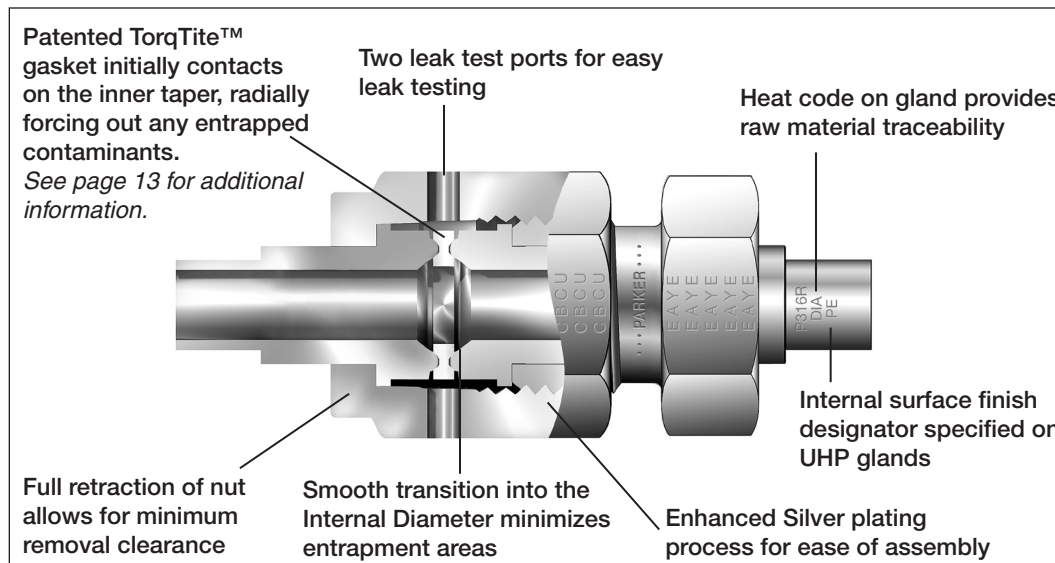

For Make-Up Instructions see page 14.

For Ordering Instructions see page 15.

Glands

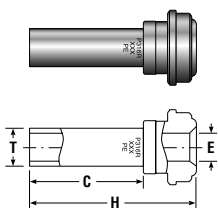

Short Tube Butt Weld

T Tube O.D.	Ordering Number	C		E		H		Normal Wall Thickness	Working Pressure	
		in.	mm	in.	mm	in.	mm		psi	bar
<i>fractional</i>										
1/8	2-2 V1T3-* 1.08	0.75	19.0	0.07	1.8	1.08	27.4	0.028	8500	580
1/4	^4-4 V1M-* .60	0.25	6.3	0.18	4.6	0.60	15.2	0.035	5100	350
1/4	4-4 V1TW-* .72	0.38	9.7	0.18	4.6	0.72	18.3	0.035	5100	350
1/4	4-4 V1T3-* 1.10	0.75	19.0	0.18	4.6	1.10	27.9	0.035	5100	350
1/4	8-4 V1T3-* 1.12	0.75	19.0	0.18	4.6	1.12	28.4	0.035	3500	240
3/8	8-6 V1M-* .62	0.25	6.3	0.31	7.9	0.62	15.7	0.035	3300	220
3/8	8-6 V1T3-* 1.12	0.75	19.0	0.31	7.9	1.12	28.4	0.035	3300	220
1/2	^^8-8 V1M-* .62	0.25	6.3	0.40	10.2	0.62	15.7	0.049	3500	240
1/2	8-8 V1TW-* .74	0.38	9.7	0.40	10.2	0.74	18.8	0.049	3500	240
1/2	8-8 V1T3-* 1.12	0.75	19.0	0.40	10.2	1.12	28.4	0.049	3500	240
<i>metric</i>										
6 mm	4-6M V1T3-* 1.16	0.75	19.0	0.16	4.1	1.16	29.5	1.0 mm	6800	460
8 mm	4-8M V1T3-* 1.16	0.75	19.0	0.24	6.1	1.16	29.5	1.0 mm	4900	330
10 mm	8-10M V1T3-* 1.16	0.75	19.0	0.31	7.9	1.16	29.5	1.0 mm	3500	240
12 mm	8-12M V1T3-* 1.16	0.75	19.0	0.39	9.9	1.16	29.5	1.0 mm	3100	210
18 mm	12-18M V1T3-* 1.22	0.75	19.0	0.59	15.0	1.22	31.0	1.5 mm	3000	200

^Old Part Number 4-4 V1M-* .035

^^Old Part Number 8-8 V1M-* .049

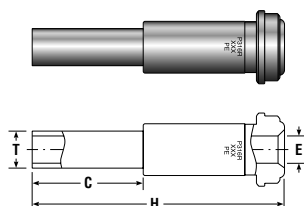

Long Tube Weld

T Tube O.D.	Ordering Number	C		E		H		Normal Wall Thickness	Working Pressure	
		in.	mm	in.	mm	in.	mm		psi	bar
<i>fractional</i>										
1/8	2-2 V1T3-* 1.42	0.75	19.0	0.07	1.8	1.42	36.1	0.028	8500	580
1/4	4-4 V1M-* 1.20	0.25	6.3	0.18	4.6	1.20	30.5	0.035	5100	350
1/4	4-4 V1T3-*	0.40	10.2	0.18	4.6	1.31	33.3	0.035	5100	350
1/4	4-4 V1TW-* 1.32	0.38	9.7	0.18	4.6	1.32	33.5	0.035	5100	350
1/4	4-4 V1T3-* 1.70	0.75	19.0	0.18	4.6	1.70	43.2	0.035	5100	350
1/4	8-4 V1T3-* 1.79	0.75	19.0	0.18	4.6	1.80	45.7	0.035	3500	240
3/8	8-6 V1M-* 1.29	0.25	6.3	0.31	7.9	1.29	32.8	0.035	3300	220
3/8	8-6 V1T3-* 1.79	0.75	19.0	0.31	7.9	1.79	45.5	0.035	3300	220
1/2	8-8 V1M-* 1.29	0.25	6.3	0.40	10.2	1.29	32.8	0.049	3500	240
1/2	8-8 V1TW-* 1.41	0.38	9.7	0.40	10.2	1.41	35.8	0.049	3500	240
1/2	8-8 V1T3-* 1.79	0.75	19.0	0.40	10.2	1.79	45.5	0.049	3500	240
3/4	12-12 V1T3-* 2.03	0.75	19.0	0.65	16.5	2.03	51.6	0.049	2400	160
1	16-16 V1T3-* 2.32	0.75	19.0	0.87	22.1	2.32	58.9	0.065	2400	160
<i>metric</i>										
6 mm	4-6M V1T3-* 1.70	0.75	19.0	0.16	4.1	1.70	43.2	1.0 mm	6800	460
8 mm	4-8M V1T3-* 1.70	0.75	19.0	0.24	6.1	1.70	43.2	1.0 mm	4900	330
10 mm	8-10M V1T3-* 1.79	0.75	19.0	0.31	7.9	1.79	45.5	1.0 mm	3500	240
12 mm	8-12M V1T3-* 1.79	0.75	19.0	0.39	9.9	1.79	45.5	1.0 mm	3100	210
18 mm	12-18M V1T3-* 2.03	0.75	19.0	0.59	15.0	2.03	51.6	1.5 mm	3000	200

Short Automatic Tube Butt Weld

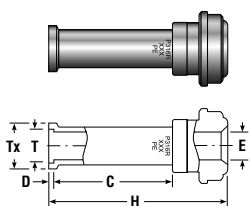

T Tube Size	Ordering Number	C		D		E		H		Tx	Normal Wall Thickness	Working Pressure		
		in.	mm	in.	mm	in.	mm	in.	mm	in.		mm	psi	bar
<i>fractional</i>														
1/4	4-4 V1Y3-* 1.12	0.75	19.0	0.02	0.5	0.18	4.6	1.12	28.4	0.29	7.4	0.035	5100	250
1/2	8-8 V1Y3-* 1.16	0.75	19.0	0.04	1.0	0.40	10.2	1.16	29.5	0.55	14.0	0.049	3500	240
3/8	8-6 V1Y3-* 1.15	0.75	19.0	0.03	0.8	0.30	7.6	1.15	29.2	0.41	10.4	0.035	3300	220
<i>metric</i>														
6 mm	4-6M V1Y3-* 1.18	0.75	19.0	0.02	0.5	0.16	4.1	1.18	30.0	0.27	6.9	1.0 mm	6800	460
8 mm	4-8M V1Y3-* 1.19	0.75	19.0	0.03	0.8	0.24	6.1	1.19	30.2	0.35	8.9	1.0 mm	4900	330
10 mm	8-10M V1Y3-* 1.22	0.75	19.0	0.03	0.8	0.31	7.9	1.22	31.0	0.43	10.9	1.0 mm	3500	240
12 mm	8-12M V1Y3-* 1.20	0.75	19.0	0.04	1.0	0.39	9.9	1.20	30.5	0.52	13.2	1.0 mm	3100	210

Glands (Continued)

Long Automatic Tube Butt Weld

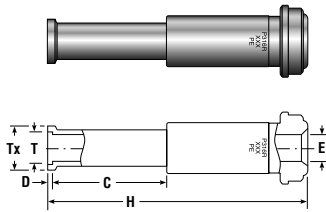

T Tube Size	Ordering Number	C		D		E		H		Tx		Normal Wall Thickness	Working Pressure	
		in.	mm	in.	mm	in.	mm	in.	mm	in.	mm		psig	bar
fractional														
1/4	4-4 V1Y3-* 1.72	0.75	19.0	0.02	0.5	0.18	4.6	1.72	43.7	0.29	7.4	0.035	5100	350
1/4	8-4 V1Y3-* 1.82	0.75	19.0	0.02	0.5	0.18	4.6	1.82	46.2	0.29	7.4	0.035	5100	350
3/8	8-6 V1Y3-* 1.82	0.75	19.0	0.03	0.8	0.31	7.9	1.82	46.2	0.41	10.4	0.035	3300	220
1/2	8-8 V1Y3-* 1.83	0.75	19.0	0.04	1.0	0.40	10.2	1.83	46.5	0.55	14.0	0.049	3500	240
3/4	12-12 V1Y3-* 2.07	0.75	19.0	0.04	1.0	0.65	16.5	2.07	52.6	0.80	20.3	0.049	2400	160
1	16-16 V1Y3-* 2.57	0.96	24.4	0.04	1.0	0.87	22.1	2.57	65.3	1.06	26.9	0.065	2400	160
metric														
6 mm	4-6M V1Y3-* 1.72	0.75	19.0	0.02	0.5	0.16	4.1	1.72	43.7	0.27	6.9	1.0 mm	6800	460
12 mm	8-12M V1Y3-* 1.83	0.75	19.0	0.04	1.0	0.39	9.9	1.83	46.5	0.52	13.2	1.0 mm	3100	210
18 mm	12-18M V1Y3-* 2.07	0.75	19.0	0.04	1.0	0.59	15.0	2.07	52.6	0.76	19.3	1.5 mm	3000	200

Short Socket Weld

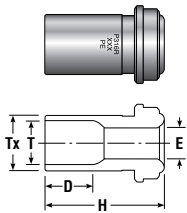

T Tube Socket	Ordering Number	D		E		H		Tx		Working Pressure	
		in.	mm	in.	mm	in.	mm	in.	mm	psig	bar
fractional											
1/4	4-4 V1W-* .50	0.28	7.1	0.19	4.8	0.50	12.7	0.35	8.9	5500	370
1/4	4-4 V1W-* .75	0.28	7.1	0.19	4.8	0.75	19.0	0.35	8.9	5500	370

Socket Weld

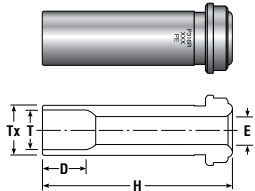

T Tube Socket	Ordering Number	D		E		H		Tx		Working Pressure	
		in.	mm	in.	mm	in.	mm	in.	mm	psig	bar
fractional											
1/16	1-1 V1W-* ①	0.10	2.5	0.05	1.3	0.70	17.8	0.13	3.3	9000	620
1/8	2-2 V1W-* .70	0.10	2.5	0.09	2.3	0.70	17.8	0.20	5.1	7100	480
1/4	4-4 V1W-*	0.28	7.1	0.19	4.6	1.31	33.3	0.35	8.9	5500	370
3/8	8-6 V1W-*	0.31	7.9	0.28	7.1	1.50	38.1	0.60	15.2	3500	240
1/2	8-8 V1W-*	0.38	9.7	0.40	10.2	1.50	38.1	0.60	15.2	3000	200
3/4	12-12 V1W-*	0.44	11.2	0.62	15.7	2.00	50.8	0.88	22.4	2800	190
1	16-16 V1W-*	0.62	15.7	0.87	22.1	2.22	56.4	1.19	30.2	2400	160

Reducing Socket Weld

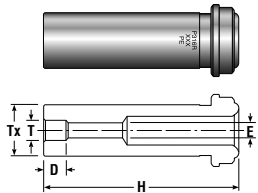

T Tube Socket	Ordering Number	D		E		H		Tx		Working Pressure	
		in.	mm	in.	mm	in.	mm	in.	mm	psig	bar
fractional											
1/8	4-2 V1W-* 1.31	0.16	4.1	0.09 ②	2.3	1.31	33.3	0.35	8.9	8000	550
1/4	8-4 V1W-*	0.25	6.3	0.19	4.8	1.50	38.1	0.60	15.2	3500	240

Blind (undrilled) Gland

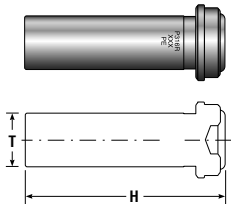

T Tube O.D.	Ordering Number	H	
		in.	mm
fractional			
1/8	2-2 V1W-* -BL	0.70	17.8
1/4	4-4 V1W-* -BL	1.31	33.3
1/2	8-8 V1W-* -BL	1.50	38.1
3/4	12-12 V1W-* -BL	2.00	50.8
1	16-16 V1W-* -BL	2.22	56.4

- ① Uses 2 BV-SS and 2 BVI-SS nuts
- ② May contain internal transitions
- ③ O-rings fluorocarbon is standard. Contact local Parker representative for other available materials

VacuSeal™ Fittings

Glands (Continued)

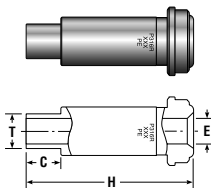

Male Weld

T Tube O.D.	Ordering Number	C		E		H		Working Pressure	
		in.	mm	in.	mm	in.	mm	psig	bar
<i>fractional</i>									
1/8	2-2 V1T3-* .70 .035	0.28	7.1	0.06	1.5	0.70	17.8	9000	620
1/8	4-2 V1T3-* 1.31 .035	0.28	7.1	0.06	1.5	1.31	33.3	8000	550
1/4	4-4 V1T3-* 1.31 .065	0.41	10.4	0.12	3.0	1.31	33.3	8000	550
1/4	8-4 V1T3-* D970351	0.41	10.4	0.12	3.0	1.50	38.1	3500	240
3/8	8-6 V1T3-* 1.50 .049	0.41	10.4	0.28	7.1	1.50	38.1	3500	240
1/2	8-8 V1T3-*	0.50	12.7	0.40	10.2	1.50	38.1	3500	240
3/4	12-12 V1T3-* 2.00 .109	0.62	15.7	0.53	13.5	2.00	50.8	3000	200
1	16-16 V1T3-* 2.22 .120	0.81	20.6	0.75	19.0	2.22	56.4	2400	160

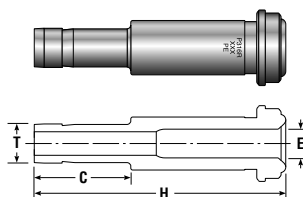

Tube Adapter (A-LOK®)

T Tube O.D.	Ordering Number	C		E		H		Working Pressure	
		in.	mm	in.	mm	in.	mm	psig	bar
<i>fractional</i>									
1/4	4-4 V1TU-*	0.62	15.7	0.16	4.1	1.62	41.1	8000	550
3/8	8-6 V1TU-*	0.69	17.5	0.28	7.1	1.81	46.0	3500	240
1/2	8-8 V1TU-*	0.91	23.1	0.39	9.9	1.78	45.2	3500	240

Replace 'U' with a '2' to designate groove for CPI™ Fitting.

Bodies

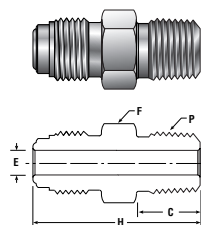

Male NPT Connector

P Male NPT Size	Ordering Number	C		E		F Hex Flat	H		Working Pressure	
		in.	mm	in.	mm		in.	mm	psig	bar
<i>fractional</i>										
1/16	2-1 FV-SS	0.38	9.6	0.09	2.3	3/8	1.07	27.2	9000	620
1/8	2-2 FV-SS	0.38	9.6	0.09	2.3	7/16	1.07	27.2	9000	620
1/8	4-2 FV-SS	0.38	9.6	0.19	4.8	5/8	1.28	32.5	8000	550
1/4	4-4 FV-SS	0.57	14.5	0.25	6.4	5/8	1.49	37.8	8000	550
3/8	8-6 FV-SS	0.57	14.5	0.38	9.6	15/16	1.62	41.1	3500	240
1/2	8-8 FV-SS	0.76	19.3	0.41	10.4	15/16	1.81	46.0	3500	240
3/4	12-12 FV-SS	0.76	19.3	0.62	15.7	1 15/16	2.19	55.6	3000	200
1	16-16 FV-SS	0.95	24.1	0.87	22.1	1 15/16	2.47	62.7	2400	160

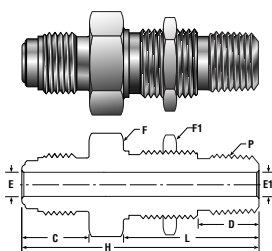

Male Bulkhead Connector

P Male NPT Size	Ordering Number	C		D		E		E1		F Hex Flat	F1 Hex Flat	H		L		Panel Hole Size	Max. Panel Thick- ness	Working Pressure	
		in.	mm	in.	mm	in.	mm	in.	mm			in.	mm	in.	mm			psig	bar
<i>fractional</i>																			
1/4	4-4 VH2BF-SS	0.62	15.7	0.57	14.5	0.25	6.4	0.25	6.4	13/16	13/16	2.21	56.134	1.24	31.5	21/32	0.38	8000	550
1/4	8-4 VH2BF-SS	0.75	19.1	0.57	14.5	0.41	10.4	0.28	7.1	15/16	13/16	2.34	59.436	1.24	31.5	21/32	0.38	3500	240

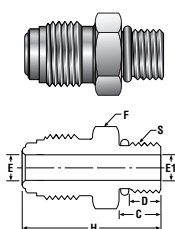

Straight Thread O-Ring Seal Male Connector ³

S Straight Thread Size	Ordering Number	C		D		E		E1		F Hex Flat	H		Uniform O-Ring Size	Working Pressure	
		in.	mm	in.	mm	in.	mm	in.	mm		psig	bar			
<i>fractional</i>															
9/16-18	4-6 VHOA-SS	0.39	9.9	0.25	6.4	0.18	4.6	0.28	7.1	3/4	1.33	33.78	Fluorocarbon 906	4500	310
7/8-14	8-10 VHOA-SS	0.50	12.7	0.4	10.2	0.28	7.1	0.59	15.0	1	1.66	42.16	Fluorocarbon 910	3500	240
9/16-18	8-6 VHOA-SS	0.39	9.9	0.39	9.9	0.28	7.1	0.28	7.1	15/16	1.48	7.59	Fluorocarbon 906	3500	240

Bodies (Continued)

Female NPT Connector

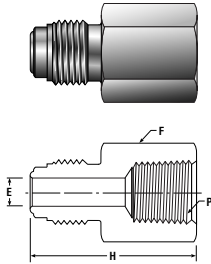

P Female NPT Size	Ordering Number	E		F Hex Flat	H		Working Pressure	
		in.	mm		in.	mm	psig	bar
<i>fractional</i>								
1/8	4-2 GV-SS	0.18	4.6	5/8	1.41	35.8	8000	550
1/4	4-4 GV-SS	0.25	6.4	3/4	1.44	36.6	6600	450
3/8	8-6 GV-SS	0.41	10.4	15/16	1.62	41.1	3500	240
1/2	8-8 GV-SS	0.41	10.4	1 1/16	1.91	48.5	3500	240
3/4	12-12 GV-SS	0.62	15.7	1 5/16	2.36	59.9	3000	200
1	16-16 GV-SS	0.87	22.1	1 5/8	2.51	63.8	2400	160

Compression Tube Fitting Connector (A-LOK®)

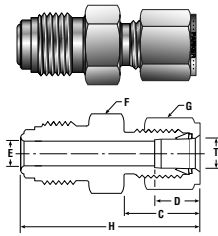

T Tube O.D.	Ordering Number	C		D		E		F Hex Flat	G Hex Flat	H		Working Pressure	
		in.	mm	in.	mm	in.	mm			in.	mm	psig	bar
<i>fractional</i>													
1/8	2-2 VHLZ-SS	0.60	15.2	0.50	12.7	0.09	2.3	5/8	7/16	1.53	38.86	8000	550
1/4	4-4 VHLZ-SS	0.70	17.8	0.60	15.2	0.19	4.8	5/8	9/16	1.62	41.15	8000	550
3/8	8-6 VHLZ-SS	0.76	19.3	0.66	16.8	0.28	7.1	15/16	11/16	1.84	46.74	3500	240
1/2	8-8 VHLZ-SS	0.87	22.1	0.90	22.9	0.41	10.4	15/16	7/8	1.95	49.53	3500	240

Dimensions - C, D, H are typical finger-tight.

Instrumentation Master Binder.

Change "L" to a "B" to select CPI™ one ferrule connector.

For maximum pressure ratings reference the Instrument Tubing Selection Guide, found in the Technical Section of your Parker

Compression Tube Fitting Bulkhead Connector (A-LOK®)

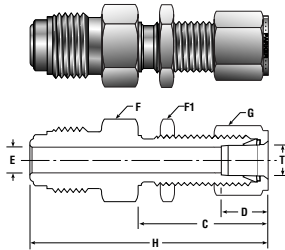

T Tube O.D.	Ordering Number	C		D		E		F Hex Flat	F1 Hex Flat	G Hex Flat	H		Panel Hole Size	Max. Panel Thick- ness	Working Pressure	
		in.	mm	in.	mm	in.	mm				in.	mm			psig	bar
<i>fractional</i>																
1/4	4-4 VH2LZ-SS	1.32	33.5	0.60	15.2	0.18	4.6	5/8	5/8	9/16	2.25	57.2	15/32	0.40	8000	550
1/4	4-4 VH2LZ-SS 1.88	1.05	26.7	0.60	15.2	0.18	4.6	5/8	5/8	9/16	1.88	47.8	15/32	0.13	8000	550
3/8	8-6 VH2LZ-SS	1.45	36.8	0.66	16.8	0.28	7.1	15/16	3/4	11/16	2.54	64.5	19/32	0.44	3500	240
1/2	8-8 VH2LZ-SS	1.65	41.9	0.90	22.9	0.41	10.4	15/16	7/8	7/8	2.74	69.6	25/32	0.50	3500	240

Dimensions - C, D, H are typical finger-tight.

Instrumentation Master Binder.

Change "L" to a "B" to select CPI™ one ferrule connector.

For maximum pressure ratings reference the Instrument Tubing Selection Guide, found in the Technical Section of your Parker

Double Male Union

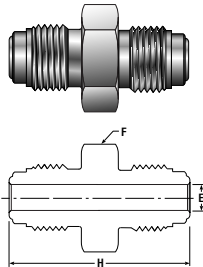

Size	Ordering Number	E		F Hex Flat	H		Working Pressure	
		in.	mm		in.	mm	psig	bar
1/8	2-2 HV-SS	0.09	2.3	3/8	1.13	28.7	9000	620
1/4	4-4 HV-SS	0.25	6.4	5/8	1.53	38.9	8000	550
1/2	8-8 HV-SS	0.41	10.4	15/16	1.84	46.7	3500	240
3/4	12-12 HV-SS	0.62	15.7	1 5/16	2.44	62.0	3000	200
1	16-16 HV-SS	0.87	22.1	1 5/8	2.59	65.8	2400	160

Double Male Reducing Union

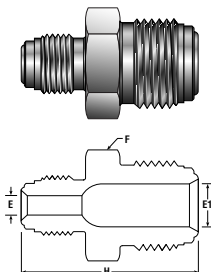

Size	Ordering Number	E		E1		F Hex Flat	H		Working Pressure	
		in.	mm	in.	mm		in.	mm	psig	bar
1/4x1/8	4-2 HV-SS	0.09	2.3	0.18	4.6	5/8	1.37	34.8	8000	550
1/2x1/4	8-4 HV-SS	0.18	4.6	0.41	10.4	15/16	1.71	43.4	3500	240

- ① Uses 2 BV-SS and 2 BVI-SS nuts
- ② May contain internal transitions
- ③ O-rings fluorocarbon is standard.
Contact local Parker representative
for other available materials

Bodies (Continued)

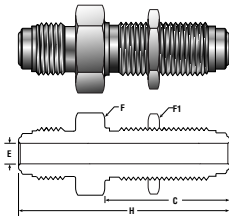

Bulkhead Union

Size	Ordering Number	C		E		F Hex Flat	F1 Hex Flat	H		Panel Hole Size	Max. Panel Thickness	Working Pressure	
		in.	mm	in.	mm	in.	mm	in.	mm			psig	bar
1/4	4-4 WBV-SS 2.23	1.30	33.0	0.25	6.4	3/4	3/4	2.23	56.6	19/32	0.44	8000	550
1/4	4-4 WBV-SS 1.82	0.99	25.1	0.25	6.4	3/4	3/4	1.82	46.2	19/32	0.13	8000	550
1/2	8-8 WBV-SS 2.57	1.45	36.8	0.41	10.4	1 1/16	1 1/16	2.57	65.3	29/32	0.50	3500	240
1/2	8-8 WBV-SS 2.14	1.11	28.2	0.41	10.4	1 1/16	1 1/16	2.14	54.4	29/32	0.13	3500	240

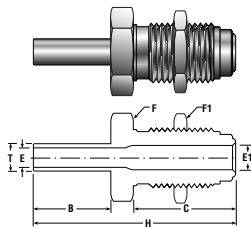

Tube Butt Weld Bulkhead Connector

T Tube O.D. Size	Ordering Number	B		C		E		E1		F Hex Flat	F1 Hex Flat	H		Panel Hole Size	Max. Panel Thickness	Working Pressure	
		in.	mm	in.	mm	in.	mm	in.	mm	in.	mm	in.	mm			psig	bar
<i>fractional</i>																	
1/4	4-4 T3H2BV-* 2.36	0.75	19.1	1.30	33.0	0.18	4.6	0.22	5.6	3/4	3/4	2.36	59.9	19/32	0.44	5100	350
1/4	4-4 T3H2BV-* 1.95	0.75	19.1	0.99	25.1	0.18	4.6	0.22	5.6	3/4	3/4	1.95	49.5	19/32	0.13	5100	350

Coupling

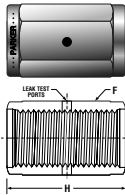

Size	Ordering Number	F Hex Flat	H	
		in.	mm	
1/8	2 VHC-SS	7/16	0.66	16.8
1/4	4 VHC-SS	3/4	1.19	30.2
1/2	8 VHC-SS	1 1/16	1.31	33.3
3/4	12 VHC-SS	1 1/2	1.68	42.7
1	16 VHC-SS	1 3/4	2.04	51.8

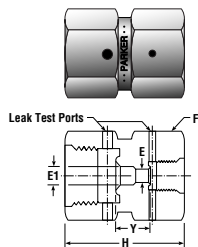

Double Female Reducing Union

Size	Ordering Number	E		E1		F Hex Flat	H		Y		Working Pressure	
		in.	mm	in.	mm	in.	mm	in.	mm	psig	bar	
1/4x1/8	4-2 HV7-SS	0.13	3.3	.25	6.4	3/4	1.16	29.5	0.36	9.1	8000	550
1/2x1/4	8-4 HV7-SS	0.25	6.4	.41	10.3	1 1/16	1.41	35.8	0.35	8.9	3500	240

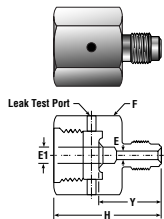

Reducing Adapter

Size	Ordering Number	E		E1		F Hex Flat	H		Y		Working Pressure	
		in.	mm	in.	mm	in.	mm	in.	mm	psig	bar	
1/8x1/4	4-2 V7HV-SS	0.09	2.3	.25	6.4	3/4	1.19	30.2	0.69	17.5	8000	550
1/4x1/2	8-4 V7HV-SS	0.18	4.6	.41	10.3	1 1/16	1.41	35.8	0.85	21.6	3500	240

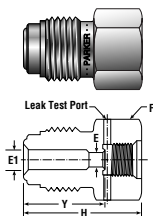

Reducing Bushing

Size	Ordering Number	E		E1		F Hex Flat	H		Y		Working Pressure	
		in.	mm	in.	mm	Hex Flat	in.	mm	in.	mm	psig	bar
1/4x1/8	4-2 VH7-SS	0.13	3.3	.18	4.6	5/8	1.06	26.9	0.76	19.3	8000	550
1/2x1/4	8-4 VH7-SS	0.25	6.4	.41	10.3	15/16	1.41	35.8	0.91	23.1	3500	240

Bodies (Continued)

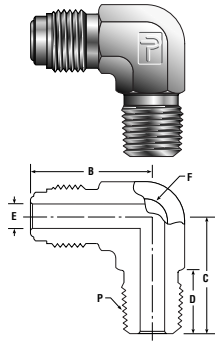

VacuSeal™ To Male NPT Elbow

P Male NPT Size	Ordering Number	B		C		D		E		F Hex Flat	Working Pressure	
		in.	mm	in.	mm	in.	mm	in.	mm		psig	bar
1/8	2-2 CV-SS	1.07	27.2	0.87	22.1	0.38	9.6	0.18	4.6	9/16	8000	550
1/4	4-4 CV-SS	1.13	28.7	1.06	26.9	0.57	14.5	0.25	6.4	9/16	8000	550
3/8	8-6 CV-SS	1.45	36.8	1.26	32.0	0.57	14.5	0.40	10.2	7/8	3500	240
1/2	8-8 CV-SS	1.31	33.3	1.31	33.3	0.76	19.3	0.41	10.4	7/8	3500	240

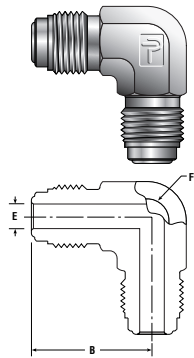

Union Elbow

Size	Ordering Number	B		E		F Wrench Flat	Working Pressure	
		in.	mm	in.	mm		psig	bar
1/8	2-2 EV-SS	0.89	22.6	0.09	2.3	7/16	9000	620
1/4	4-4 EV-SS	1.13	28.7	0.25	6.4	9/16	8000	550
1/2	8-8 EV-SS	1.31	33.3	0.41	10.4	7/8	3500	240
3/4	12-12 EV-SS	1.92	48.8	0.62	15.7	1 1/4	3000	200
1	16-16 EV-SS	2.00	50.8	0.87	22.1	1 5/8	2400	160

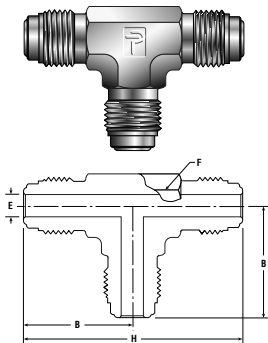

Union Tee

Size	Ordering Number	B		E		H		F Wrench Flat	Working Pressure	
		in.	mm	in.	mm	in.	mm		psig	bar
1/8	2-2-2 JV-SS	0.89	22.6	0.09	2.3	1.78	45.21	7/16	9000	620
1/4	4-4-4 JV-SS	1.13	28.7	0.25	6.4	2.25	57.15	9/16	8000	550
1/2	8-8-8 JV-SS	1.31	33.3	0.41	10.4	2.62	66.55	7/8	3500	240
3/4	12-12-12 JV-SS	1.92	48.8	0.62	15.7	3.84	97.54	1 1/4	3000	200
1	16-16-16 JV-SS	2.00	50.8	0.87	22.1	4.00	101.6	1 5/8	2400	160

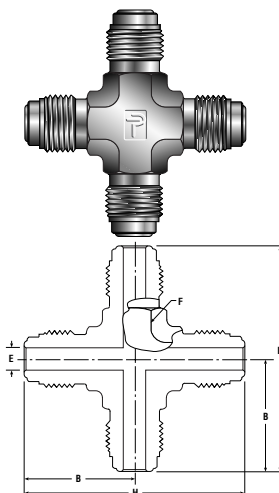

Union Cross

Size	Ordering Number	B		E		H		F Wrench Flat	Working Pressure	
		in.	mm	in.	mm	in.	mm		psig	bar
1/8	2 KV-SS	0.89	22.6	0.09	2.3	1.78	45.21	7/16	9000	620
1/4	4 KV-SS	1.13	28.7	0.25	6.4	2.25	57.15	9/16	8000	550
1/2	8 KV-SS	1.45	36.8	0.41	10.4	2.90	73.66	7/8	3500	240
3/4	12 KV-SS	1.92	48.8	0.62	15.7	3.84	97.54	1 1/4	3000	200
1	16 KV-SS	2.00	50.8	0.87	22.1	4.00	101.6	1 5/8	2400	160

- ① Uses 2 BV-SS and 2 BVI-SS nuts
- ② May contain internal transitions
- ③ O-rings fluorocarbon is standard.
Contact local Parker representative
for other available materials

Welded Assemblies

Male NPT Connector

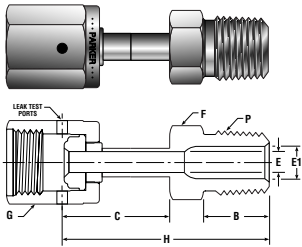

P Male NPT Size	Ordering Number	B		C		E		E1		F Hex Flat	G Hex Flat	H		Working Pressure	
		in.	mm	in.	mm	in.	mm	in.	mm	in.	mm	in.	mm	psig	bar
fractional															
1/8	2-2 V1HBF-*	.38	9.6	0.95	24.1	0.18	4.6	0.19	4.8	7/16	3/4	1.58	40.1	8000	550
1/4	4-4 V1HBF-*	.57	14.5	0.93	23.6	0.18	4.6	0.28	7.1	9/16	3/4	1.79	45.5	5100	350
3/8	8-6 V1HBF-*	.57	14.5	1.00	25.4	0.40	10.2	0.41	10.3	1 1/16	1 1/16	1.89	48.0	3500	240
1/2	8-8 V1HBF-*	.76	19.3	1.01	25.6	0.40	10.2	0.53	13.5	7/8	1 1/16	2.09	53.1	3500	240

Female NPT Connector

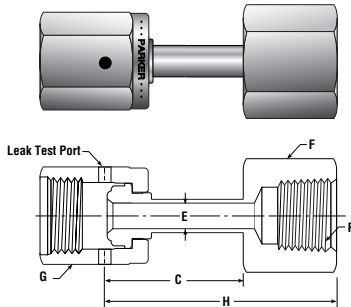

P Female NPT Size	Ordering Number	C		E		F Hex Flat	G Hex Flat	H		Working Pressure	
		in.	mm	in.	mm	in.	mm	in.	mm	psig	bar
fractional											
1/4	4-4 V1HBG-*	1.05	26.7	0.18	4.6	3/4	3/4	1.77	45.0	5100	350
3/8	8-6 V1HBG-*	1.06	26.9	0.40	10.2	7/8	1 1/16	1.95	49.5	3500	240
1/2	8-8 V1HBG-*	1.04	26.4	0.40	10.2	1 1/16	1 1/16	2.18	55.4	3500	240

Compression Tube Fitting Connector (A-LOK)

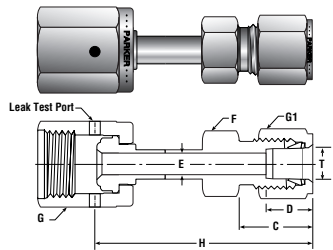

T Tube O.D.	Ordering Number	C		D		E		F Hex Flat	G Hex Flat	G1 Hex Flat	H		Working Pressure		
		in.	mm	in.	mm	in.	mm	in.	mm	in.	mm	psig	bar		
fractional															
1/4	4-4 V1HLZ-*	0.70	17.8	0.60	15.2	0.18	4.6	1/2	3/4	9/16	1.94	49.3	5100	350	
3/8	4-6 V1HLZ-*	0.76	19.3	0.67	17.0	0.18	4.6	5/8	3/4	11/16	1.97	50.0	5100	350	
1/2	8-8 V1HLZ-*	0.87	22.1	0.90	22.9	0.40	10.2	13/16	1 1/16	1 7/8	2.23	56.6	3500	240	

Dimensions - C, D, H are typical finger-tight.

Change "L" to a "B" to select CPI™ one ferrule connector.

Instrumentation Master Binder.

For maximum pressure ratings reference the Instrument Tubing Selection Guide, found in the Technical Section of your Parker

Rotating Female Union

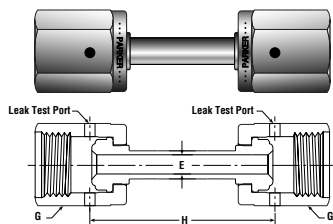

Size	Ordering Number	E		G Hex Flat	H		Working Pressure	
		in.	mm	in.	mm	psig	bar	
1/4	4-4 V1HBV1-*	.18	4.6	3/4	1.35	34.3	5100	350
1/4	4-4 V1HBV1-*.170	.18	4.6	3/4	1.70	43.2	5100	350
1/2	8-8 V1HBV1-*	.40	10.2	1 1/16	1.25	31.8	3500	240
1/2	8-8 V1HBV1-*.184	.40	10.2	1 1/16	1.84	46.7	3500	240

Female Elbow

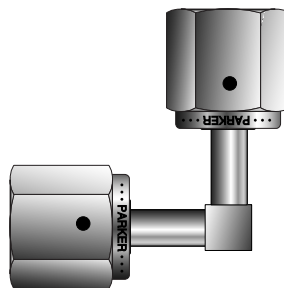

Ordering Number:
MEM-44-*VVFV

Female Tee

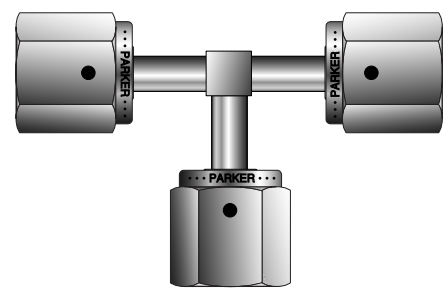

Ordering Number:
MJM-444-*VVFVVF

Welded Modules

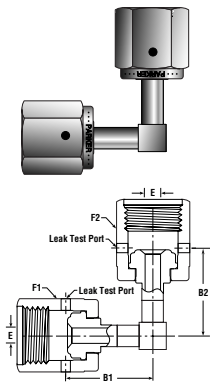

Elbow Modules

Size	Ordering Number	B1		B2		E		F1 Hex Flat	F2 Hex Flat	Working Pressure	
		in.	mm	in.	mm	in.	mm			psig	bar
fractional											
1/4	MEM-44*VMSVF	1.60	40.6	1.00	25.4	0.18	4.6	5/8	3/4	5100	350
1/4	MEM-44*VMSVMS	1.60	40.6	1.60	40.6	0.18	4.6	5/8	5/8	5100	350
1/4	MEM-44*VFVF	1.00	25.4	1.00	25.4	0.18	4.6	3/4	3/4	5100	350
1/2	MEM-88*VFVF	1.17	29.7	1.17	29.7	0.18	4.6	1 1/16	1 1/16	3500	240

Tee Modules

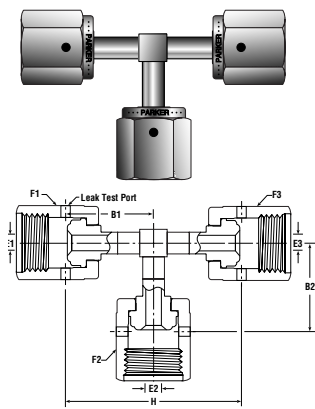

Size	Ordering Number	B1		B2		H		E1		E2		E3		F1 Hex Flat	F2 Hex Flat	F3 Hex Flat	Working Pressure	
		in.	mm	in.	mm	in.	mm	in.	mm	in.	mm	in.	mm				psig	bar
fractional																		
1/4	MJM-444*VFVFVMS	1.00	25.4	1.00	25.4	2.60	66.0	0.18	4.6	0.18	4.6	0.18	4.6	3/4	3/4	5/8	5100	350
1/4	MJM-444*VFMVMS	1.00	25.4	1.60	40.6	2.60	66.0	0.18	4.6	0.18	4.6	0.18	4.6	3/4	5/8	5/8	5100	350
1/4	MJM-444*VFVFVF	1.00	25.4	1.00	25.4	2.00	50.8	0.18	4.6	0.18	4.6	0.18	4.6	3/4	3/4	3/4	5100	350
1/4	MJM-444*VMSVMS	1.60	40.6	1.60	40.6	3.20	81.3	0.18	4.6	0.18	4.6	0.18	4.6	5/8	5/8	5/8	5100	350
1/2x1/4	MJM-884*VFVMSVF	1.17	29.7	1.12	28.4	3.20	81.3	0.40	10.2	0.18	4.6	0.40	10.2	1 1/16	3/4	15/16	3500	240

Cross Modules

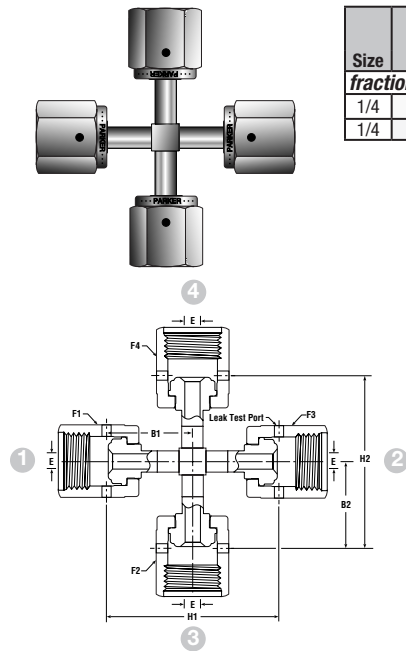

Size	Ordering Number	B1		B2		H1		H2		E		F1	F2	F3	F4	Working Pressure	
		in.	mm	in.	mm	in.	mm	in.	mm	in.	mm					psig	bar
fractional																	
1/4	MKM-4444*VMSVFVFVF	1.60	40.6	1.00	25.4	2.60	66.0	2.00	50.8	0.18	4.6	5/8	3/4	3/4	3/4	5100	350
1/4	MKM-4444*VFVFVFVF	1.00	25.4	1.00	25.4	2.00	50.8	2.00	50.8	0.18	4.6	3/4	3/4	3/4	3/4	5100	350

Welded Module Ordering Information:

MKM - 4 4 4 4 2 VF VF VF VF
 Type Size Stainless Steel 316L End Connections

VF = Female VacuSeal™ Swivel

VMS = Male VacuSeal™ Swivel

Replace asterisk with 2 to specify Stainless Steel 316L.

For additional configurations and sizes contact your local Parker Representative.

VacuSeal™ Fittings

Gaskets

VacuSeal™ gaskets are compatible with other high quality gasket face seal fittings.

Non-Retained Flat Style

Size	Ordering Number	E		H		Tx	
		in.	mm	in.	mm	in.	mm
1/8	2 VG-*	0.09	2.3	0.02	0.5	0.26	6.6
1/4	4 VG-*	0.22	5.5	0.03	0.8	0.47	11.9
1/2	8 VG-*	0.44	11.1	0.03	0.8	0.78	19.9
3/4	12 VG-*	0.66	16.8	0.03	0.8	1.14	28.9
1	16 VG-*	0.89	22.7	0.03	0.8	1.41	35.7

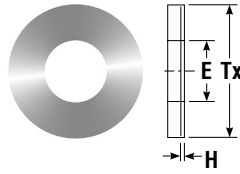

Retained Flat Style

Retainer and gasket must be used as an assembly.

Note: Nickel Retained Flat Style Gaskets utilize a Stainless Steel Retainer

Size	Ordering Number	E		H		Tx	
		in.	mm	in.	mm	in.	mm
1/4	4 VGR-*	0.23	5.8	0.03	0.8	0.50	12.7
1/2	8 VGR-*	0.44	11.2	0.03	0.8	0.79	20.1

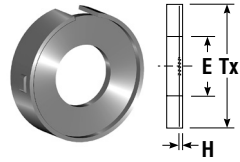

Non-Retained Grooved Style (TorqTite™ Gasket)

Size	Ordering Number	E		H		Tx		T	
		in.	mm	in.	mm	in.	mm	in.	mm
1/4	4 GVG-*	0.21	5.3	0.06	1.6	0.50	12.6	0.03	0.8
1/2	8 GVG-*	0.43	10.9	0.06	1.6	0.78	19.8	0.03	0.8

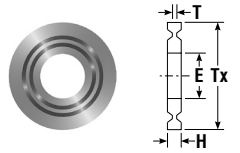

Retained Grooved Style (Retained TorqTite™ Gasket)

Size	Ordering Number	E		H		Tx		T	
		in.	mm	in.	mm	in.	mm	in.	mm
1/4	4 GVGR-*	0.21	1.3	0.06	1.6	0.49	12.4	0.03	0.8
1/2	8 GVGR-*	0.43	2.7	0.06	1.6	0.79	20.1	0.03	0.8

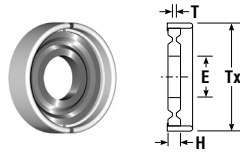

Gasket Ordering Information

Specify gasket material by replacing asterisk with appropriate Ordering Number Designator.

MATERIAL	ORDERING NUMBER DESIGNATOR	EXAMPLE
High-Purity Nickel (electropolished)	N	4 VGR-N
Stainless Steel ³	SS	4 VGR-SS
Kel-F [®] 12	K	4 VG-K
Teflon [®] 12	T	4 VG-T

Blind (undrilled) gaskets are available by adding a -BL suffix at the end of the part number.

Example: 4 VG-N-BL

- 1 Parker uses Kel-F 81[®] or equal PCTFE Polymer
Parker uses Teflon[®] or equal PTFE Polymer
- 2 Kel-F 81[®] and Teflon[®] are only available for Non-Retained Flat Style gaskets
- 3 Stainless Steel gaskets are Silver plated

Kel-F 81[®] is a registered trademark of 3M Company
Teflon[®] is a registered trademark of Dupont Company

The retainer of Parker's patented Retained Flat Gasket helps to both locate the gasket over the toroid of the gland and hold the gasket in place during assembly, therefore minimizing radial damage to the toroids of the connection.

The unique design of the retainer minimizes potential scratches or nicks to the critical toroid surfaces during placement onto the gland.

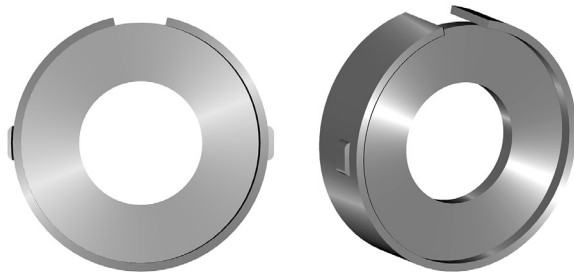

Note: All gaskets must be ordered in increments of 10

Nuts, Caps, and Plugs

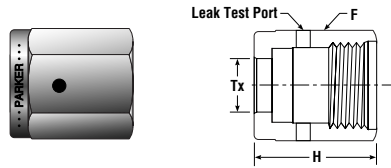

Female Nut

Ordering Number	Size	F Hex Flat	H		Tx	
			in.	mm	in.	mm
2 BV-SS	1/8	7/16	0.53	13.5	0.21	5.3
4 BV-SS*	1/4	3/4	0.82	20.8	0.36	9.1
8 BV-SS	1/2	1 1/16	0.88	22.4	0.61	15.5
12 BV-SS	3/4	1 1/2	1.12	28.4	0.89	22.6
16 BV-SS	1	1 3/4	1.34	34.0	1.20	30.5

*Previous Part Number 4 BV SS-D

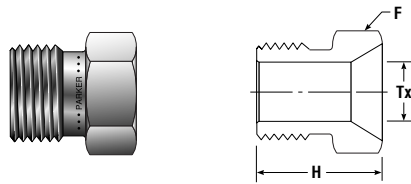

Male Nut

Ordering Number	Size	F Hex Flat	H		Tx	
			in.	mm	in.	mm
2-BVI-SS	1/8	3/8	0.50	12.7	0.21	5.3
4 BVI-SS ⁴	1/4	5/8	0.72	18.3	0.36	9.1
8-BVI-SS	1/2	15/16	0.81	20.6	0.61	15.5
12-BVI-SS	3/4	1 5/16	1.00	25.4	0.89	22.6
16-BVI-SS	1	1 5/8	1.19	30.2	1.20	30.5

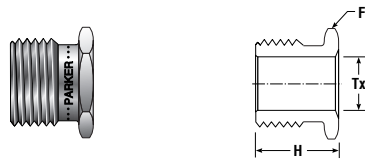

Short Male Nut

Ordering Number	Size	F Hex Flat	H		Tx	
			in.	mm	in.	mm
4 BVI .54-SS	1/4	5/8	0.54	13.7	0.36	9.1
4 BVI .65-SS	1/4	5/8	0.65	16.5	0.36	9.1

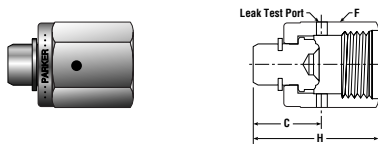

Cap

Ordering Number	Size	C		F Hex Flat	H	
		in.	mm		in.	mm
4 FNV-SS	1/4	0.59	15.0	3/4	1.09	27.7
8 FNV-SS	1/2	0.59	15.0	1 1/16	1.16	29.5
12 FNV-SS	3/4	0.66	16.8	1 1/2	1.41	35.8
16 FNV-SS	1	0.63	16.0	1 3/4	1.55	39.4

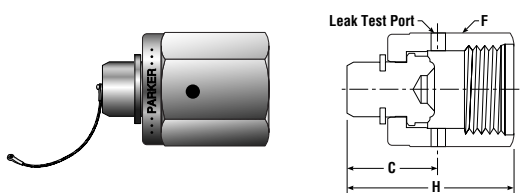

Cap With Lanyard

Ordering Number	Size	C		F Hex Flat	H		Lanyard Length	
		in.	mm		in.	mm	in.	mm
4 FNV-SS-L	1/4	0.59	15.0	3/4	1.09	27.7	6	152.4
8 FNV-SS-L	1/2	0.59	15.0	1 1/16	1.16	29.5	6	152.4

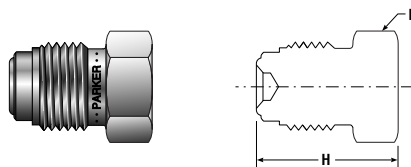

Plug

Ordering Number	Size	F Hex Flat	H	
			in.	mm
2 PNV-SS	1/8	3/8	0.68	17.3
4 PNV-SS	1/4	5/8	0.91	23.1
8 PNV-SS	1/2	15/16	1.08	27.4
12 PNV-SS	3/4	1 5/16	1.43	36.3
16 PNV-SS	1	1 5/8	1.52	38.6

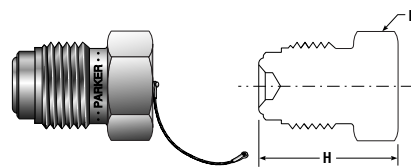

Plug With Lanyard

Ordering Number	Size	F Hex Flat	H		Lanyard Length	
			in.	mm	in.	mm
4 PNV-SS-L	1/4	5/8	0.91	23.1	6	152.4
8 PNV-SS-L	1/2	15/16	1.08	27.4	6	152.4



Protective Shipping Cap

Ordering Number	Size
C-VacuSeal	1/4

⁴ Taper in the back of nut allows mobility around 90° bends

Hi-Flo Products

Glands

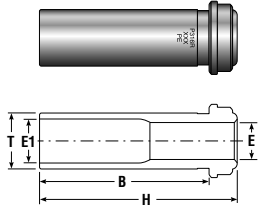

Tube Butt Weld

T Tube O.D.	Ordering Number	B		E		E1		H		Working Pressure	
		in.	mm	in.	mm	in.	mm	in.	mm	psig	bar
<i>fractional</i>											
3/8	4-6 VH1T3-*.60	0.41	10.4	0.25	6.4	0.30	7.6	0.60	15.2	3300	220
3/8	4-6 VH1T3-*	1.00	25.4	0.25	6.4	0.30	7.6	1.19	30.2	3300	220
3/8	4-6 VH1T3-*.1.31	1.12	28.4	0.25	6.4	0.30	7.6	1.31	33.3	3300	220

Bodies

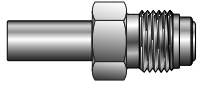

Tube Butt Weld

T Tube O.D.	Ordering Number	B		C		E		E1		F Hex Flat	H		Working Pressure	
		in.	mm	in.	mm	in.	mm	in.	mm	in.	mm	psig	bar	
<i>fractional</i>														
3/8	4-6 VHT3-*.1.68	0.75	19.1	0.62	15.7	0.25	6.4	0.30	7.6	5/8	1.68	42.7	3300	220

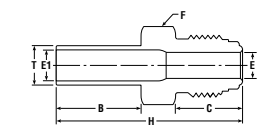

Automatic Tube Weld

T Tube O.D.	Ordering Number	B		C		D		E		E1		F Hex Flat	H		Tx	Working Pressure		
		in.	mm	in.	mm	in.	mm	in.	mm	in.	mm	in.	mm	in.	mm	psig	bar	
<i>fractional</i>																		
3/8	4-6 VHY3-*.1.71	0.75	19.1	0.62	15.7	0.03	0.8	0.25	6.4	0.30	7.6	5/8	1.71	43.4	0.41	10.4	3300	220

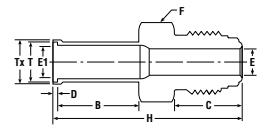

Bulkhead Connector

T Tube O.D.	Ordering Number	B		C		E		E1		F Hex Flat	F1 Hex Flat	H		Panel Hole Size	Max. Panel Thick- ness	Working Pressure	
		in.	mm	in.	mm	in.	mm	in.	mm	in.	mm	in.	mm	in.	mm	psig	bar
<i>fractional</i>																	
3/8	6-4 T3H2BV-*.2.36	0.75	19.1	1.30	33.0	0.23	5.8	0.30	7.6	3/4	3/4	2.36	60	19/32	0.44	3300	220

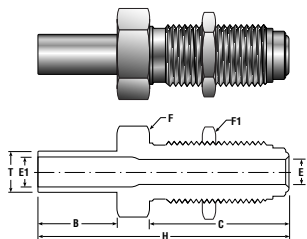

Nuts

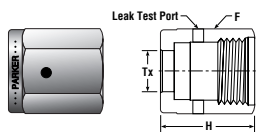

Female Nut

Size	Ordering Number	F Hex Flat	H		Tx	
			in.	mm	in.	mm
3/8	4 BVH-SS	3/4	0.82	20.8	0.39	9.9

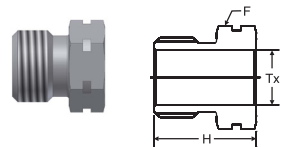

Male Nut

Size	Ordering Number	F Hex Flat	H		Tx	
			in.	mm	in.	mm
3/8	4 BVHI-SS	5/8	0.72	18.3	0.39	9.9

Featured Products

TorqTite™

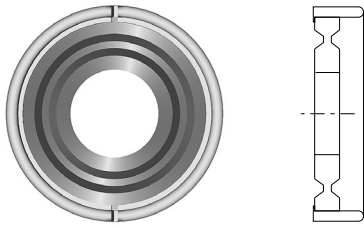

Check out the patented TorqTite™ Self-Aligning Face Seal Gasket

- Needs no installation tools
- Virtually eliminates loosening of components due to thermocycling and vibration (i.e. transportation)
- Seals even on damaged toroids
- Allows for higher torque without damaging sealing surfaces
- Easy open clean room bag requires no cutting
- Color coded retainers for material recognition
- Minimizes particle generation

*Non-Rotational Female Nut



Ordering Number: 4 BV-SS-NR

Use Parker's Non-Rotational Female Nut to prevent transmission of torque during make-up and therefore minimize twist of componentry which causes stress concentration.

Anti-Galling Female Nut

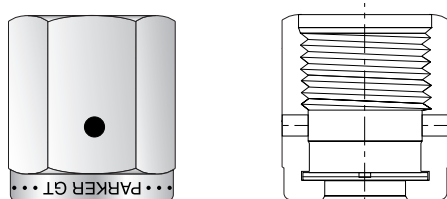

Ordering Number: 4 BV-GT

Use Parker's Anti-Galling Female Nut to ensure consistent makes and remakes without plating or lubrication on Female threads.

* Patented

Note: Outside dimensions of the Non-Rotational Female Nut and Anti-Galling Female Nut match the 4 BV-SS on Page 12.

Make-Up Instructions

Flat and Grooved Gasket Assembly

Step 1

Remove gasket from packaging.

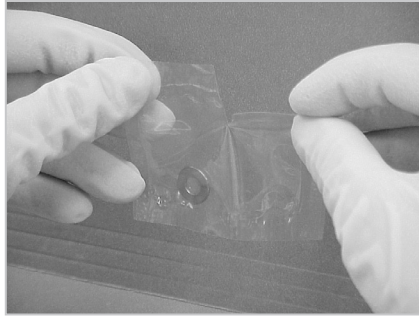

Step 2

Place gasket into female VacuSeal™ nut.

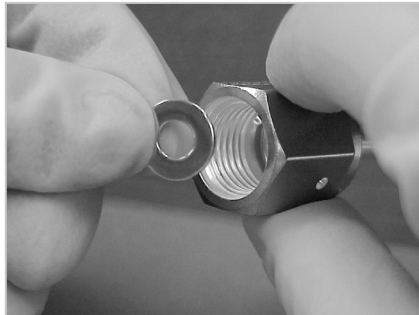

Step 3

Assemble components and snug to fingertight.

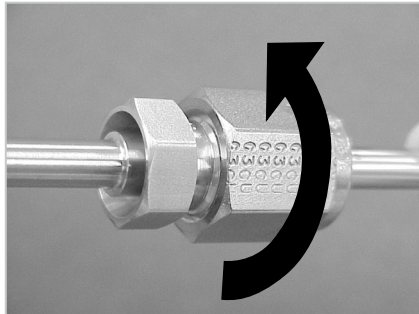

Step 4

Scribe the hex flat of both the male and female nuts.

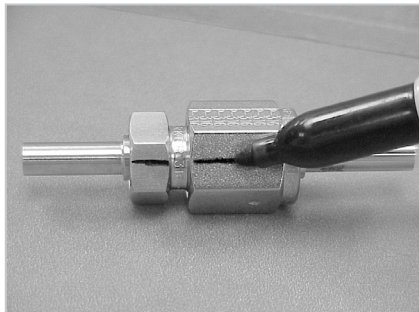

Step 5

Holding the backup wrench stationary, tighten the female nut 1/8 turn past fingertight.

Warning: Extreme over tightening will damage toroid surface and cause potential leakage.

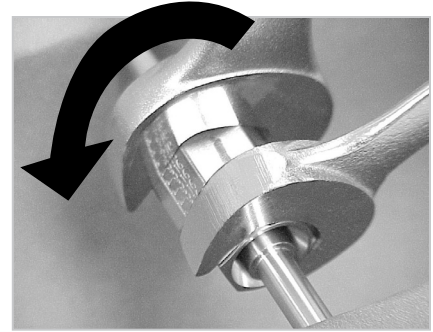

Flat Gasket Remake

Upon remake of flat VacuSeal™ gasket, a new gasket must be installed for each remake, follow procedures for initial make-up.

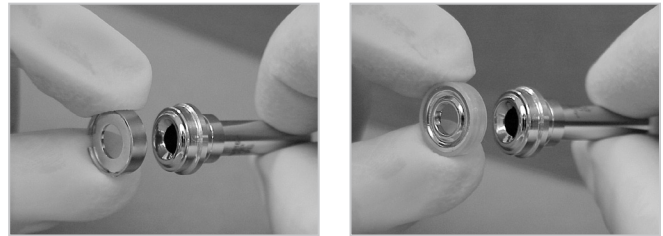

Retained Gaskets Assembly

Guide retained gaskets over gland face, then continue step 3 of Flat and Grooved Gasket Assembly for completion of make-up.

Protective Shipping Cap

Metallic protector caps are available to protect critical toroid surface from damage see page 11.



Ordering Instructions

How To Order

Parker VacuSeal™ components are ordered by Ordering Number, as listed in this catalog. Replace the asterisk within each Ordering Number with the corresponding material designator listed below.

Assembly Example:

If your system requires a VacuSeal™ assembly connecting from 1/4" O.D. tubing to 1/4" O.D. tubing, you may order the following parts.



Note: Each component must be ordered separately.

Nomenclature

Part numbers of Parker VacuSeal™ components are constructed from symbols that identify the size, configuration and material of each component.

Component Example:

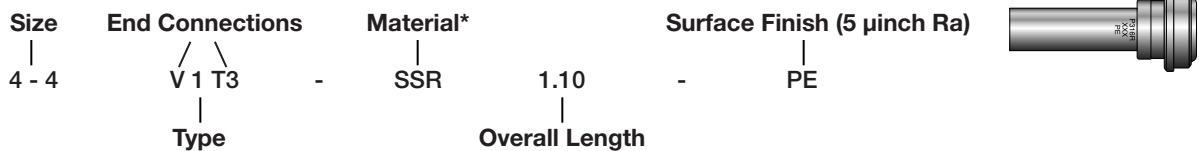

Size: Tube and Pipe are designated by the number of sixteenths of an inch. (i.e. 1/4" Pipe Thread = 4/16" = 4)
Metric Tube O.D. is designated in millimeters with the suffix "M".
(i.e. 4-6M V1T3-SSR 1.16)

Type: Designate shape of component.
(i.e. 1=gland, E=elbow, J=tee, K=cross, etc.)

***Material:** Replace asterisks in Part Number to specify material:
SS = Stainless Steel 316 (All non-welded bodies and components)
SSR = Stainless Steel 316L VAR
SSV = Stainless Steel 316L VIM/VAR
Nickel and Hastelloy C-22® available upon request.

Forged product will be offered as a 15 RA or a standard.

Size: End Connections: Specify VacuSeal™ end first, followed by other corresponding ends:
V = VacuSeal™
M = Butt weld with .25" tube stub length
T3 = Butt weld with .75" tube stub length
TW = Butt weld with various tube stub length
Y3 = Butt weld with End Collar
W = Socket Weld

Overall Length: Specify length of component in inches.

Note: Contact Parker representative for information on additional materials.

VacuSeal End Data Information

Size	VacuSeal Thread	*L	**C	H Hex	E
		in.	in.	in.	in.
4	9/16-18	.62	.97	5/8	.19
6	7/8-14	.75	1.10	15/16	.28
8	7/8-14	.75	1.10	15/16	.41
12	1-1/4-18	1.00	1.40	1-5/16	.53

*Average Value

**Dimension C is shown in the finger tight position

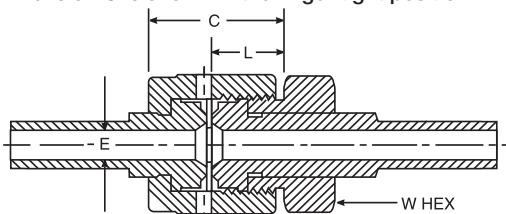

Additional Products

MiniButtwelds™

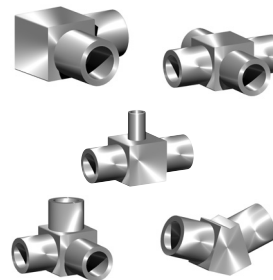

UltraSeal™ Fittings



Parker offers a full line of MiniButtweld™ products to complement the VacuSeal™ product line. Please refer to MiniButtweld™ (25000258) and UltraSeal™ (25000259) Fittings Catalogs for additional information.

Parker's Motion & Control Technologies

At Parker, we're guided by a relentless drive to help our customers become more productive and achieve higher levels of profitability by engineering the best systems for their requirements. It means looking at customer applications from many angles to find new ways to create value. Whatever the motion and control technology need, Parker has the experience, breadth of product and global reach to consistently deliver. No company knows more about motion and control technology than Parker. For further info call 1-800-C-Parker.



AEROSPACE

Key Markets

- Aircraft engines
- Business & general aviation
- Commercial transports
- Land-based weapons systems
- Military aircraft
- Missiles & launch vehicles
- Regional transports
- Unmanned aerial vehicles

Key Products

- Flight control systems & components
- Fluid conveyance systems
- Fluid metering delivery & atomization devices
- Fuel systems & components
- Hydraulic systems & components
- Inert nitrogen generating systems
- Pneumatic systems & components
- Wheels & brakes



CLIMATE CONTROL

Key Markets

- Agriculture
- Air conditioning
- Food, beverage & dairy
- Life sciences & medical
- Precision cooling
- Processing
- Transportation

Key Products

- CO₂ controls
- Electronic controllers
- Filter driers
- Hand shut-off valves
- Hose & fittings
- Pressure regulating valves
- Refrigerant distributors
- Safety relief valves
- Solenoid valves
- Thermostatic expansion valves

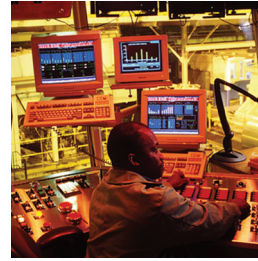

ELECTROMECHANICAL

Key Markets

- Aerospace
- Factory automation
- Life science & medical
- Machine tools
- Packaging machinery
- Paper machinery
- Plastics machinery & converting
- Primary metals
- Semiconductor & electronics
- Textile
- Wire & cable

Key Products

- AC/DC drives & systems
- Electric actuators, gantry robots & slides
- Electrohydrostatic actuation systems
- Electromechanical actuation systems
- Human machine interface
- Linear motors
- Stepper motors, servo motors, drives & controls
- Structural extrusions



FILTRATION

Key Markets

- Food & beverage
- Industrial machinery
- Life sciences
- Marine
- Mobile equipment
- Oil & gas
- Power generation
- Process
- Transportation

Key Products

- Analytical gas generators
- Compressed air & gas filters
- Condition monitoring
- Engine air, fuel & oil filtration & systems
- Hydraulic, lubrication & coolant filters
- Process, chemical, water & microfiltration filters
- Nitrogen, hydrogen & zero air generators



FLUID & GAS HANDLING

Key Markets

- Aerospace
- Agriculture
- Bulk chemical handling
- Construction machinery
- Food & beverage
- Fuel & gas delivery
- Industrial machinery
- Mobile
- Oil & gas
- Transportation
- Welding

Key Products

- Brass fittings & valves
- Diagnostic equipment
- Fluid conveyance systems
- Industrial hose
- PTFE & PFA hose, tubing & plastic fittings
- Rubber & thermoplastic hose & couplings
- Tube fittings & adapters
- Quick disconnects



HYDRAULICS

Key Markets

- Aerospace
- Aerial lift
- Agriculture
- Construction machinery
- Forestry
- Industrial machinery
- Mining
- Oil & gas
- Power generation & energy
- Truck hydraulics

Key Products

- Diagnostic equipment
- Hydraulic cylinders & accumulators
- Hydraulic motors & pumps
- Hydraulic systems
- Hydraulic valves & controls
- Power take-offs
- Rubber & thermoplastic hose & couplings
- Tube fittings & adapters
- Quick disconnects

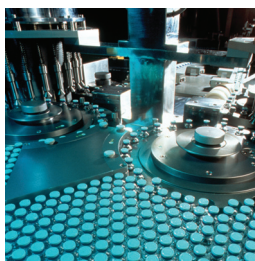

PNEUMATICS

Key Markets

- Aerospace
- Conveyor & material handling
- Factory automation
- Life science & medical
- Machine tools
- Packaging machinery
- Transportation & automotive

Key Products

- Air preparation
- Brass fittings & valves
- Manifolds
- Pneumatic accessories
- Pneumatic actuators & grippers
- Pneumatic valves & controls
- Quick disconnects
- Rotary actuators
- Rubber & thermoplastic hose & couplings
- Structural extrusions
- Thermoplastic tubing & fittings
- Vacuum generators, cups & sensors



PROCESS CONTROL

Key Markets

- Chemical & refining
- Food, beverage & dairy
- Medical & dental
- Microelectronics
- Oil & gas
- Power generation

Key Products

- Analytical sample conditioning products & systems
- Fluoropolymer chemical delivery fittings, valves & pumps
- High purity gas delivery fittings, valves & regulators
- Instrumentation fittings, valves & regulators
- Medium pressure fittings & valves
- Process control manifolds



SEALING & SHIELDING

Key Markets

- Aerospace
- Chemical processing
- Consumer
- Energy, oil & gas
- Fluid power
- General industrial
- Information technology
- Life sciences
- Military
- Semiconductor
- Telecommunications
- Transportation

Key Products

- Dynamic seals
- Elastomeric o-rings
- EMI shielding
- Extruded & precision-cut, fabricated elastomeric seals
- Homogeneous & inserted elastomeric shapes
- High temperature metal seals
- Metal & plastic retained composite seals
- Thermal management



ENGINEERING YOUR SUCCESS.

Parker Hannifin Corporation
Veriflo Division
250 Canal Blvd
Richmond, California 94804

phone 510 235 9590
fax 510 232 7396
veriflo.sales@parker.com

www.parker.com/veriflo

Parker Hannifin Corporation
Veriflo Division
Partek Operation
7075 East Southpoint Road
Tucson, Arizona 85706

phone 520 574 2600
fax 520 574 2700
partek.sales@parker.com

www.parker.com/partek

